

Pressure Gauges



Hydraulic Testers



Oil Analysis Equipment



Germany

Walter Stauffenberg GmbH & Co. KG

Im Ehrenfeld 4

58791 Werdohl

Tel.: +49 2392 91 60

Fax: +49 2392 91 61 60

E-Mail: sales@stauff.com

www.stauff.com

STAUFF products and services are globally available through wholly-owned subsidiaries and a tight network of authorised distributors and representatives in all major industrial regions of the world.

You can find detailed contact information on the last two pages of this product catalogue or at www.stauff.com.

Please note: Unless otherwise stated, all data and figures in this product catalogue are approximate values and are only valid as references, which are not binding (also in respect to any third parties' rights of protection) and thus do not release the customer / user from checking and testing the suitability of the products for the foreseen purposes. Therefore, data and figures can only be used in a limited sense for construction purposes.

The application of the products is beyond the control possibilities of the manufacturer and, therefore, is exclusively subject to the responsibility of the customer / user.

In the event that a liability is nevertheless considered, any compensation will be limited to the value of the goods supplied by the manufacturer and used by the customer / user. As a matter of course, the manufacturer guarantees the perfect quality of all products in accordance with the General Terms and Conditions of Business and Sale.

Subject to modifications due to the ongoing development and improvement of the products.

With the publication of this product catalogue, previous editions are no longer valid.

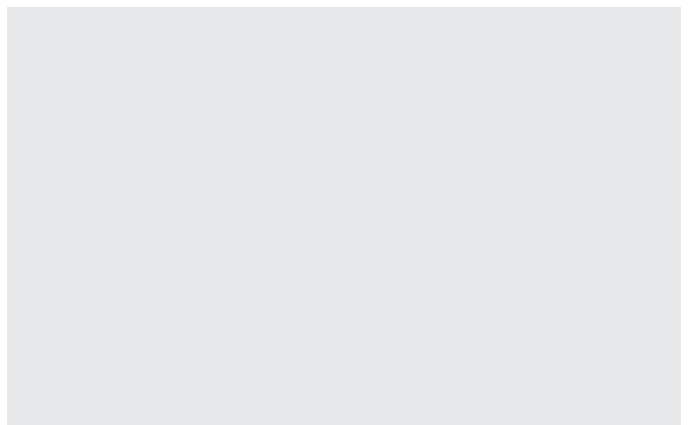
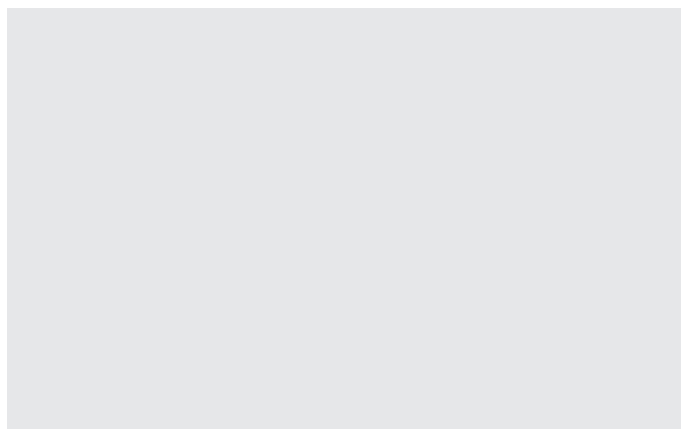

Introduction	4 - 11	
Pressure Gauges	12 - 21	A
Hydraulic Testers	22 - 57	B
Oil Analysis Equipment	58 - 77	C
Appendix (Product-Specific Abbreviations / Global Contact Directory)	78 - 83	





**Catalogue 1
STAUFF Clamps**

- Block Clamps
- Special Clamps
- Light Series Clamps
- Saddle Clamps
- U-Bolt Clamps
- Metal Clamps
- Construction Series

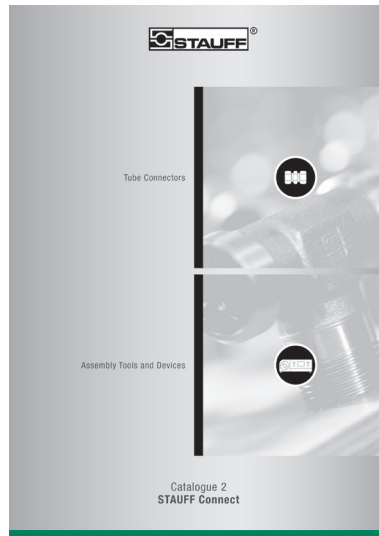

**Catalogue 2
STAUFF Connect**

- Tube Connectors
- Assembly Tools and Devices

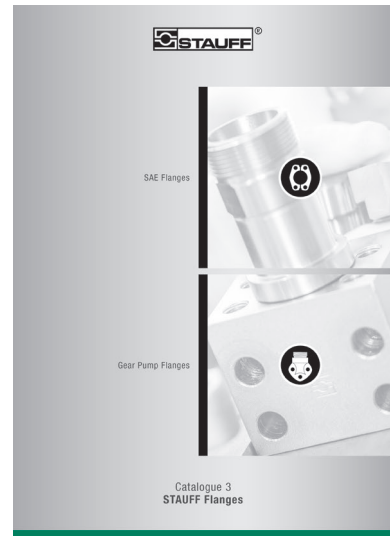

**Catalogue 3
STAUFF Flanges**

- SAE Flanges
- Gear Pump Flanges



**Catalogue 4
VOSWINKEL
Hose Connectors**

- Hose Connectors
- High-Pressure Hose Connectors

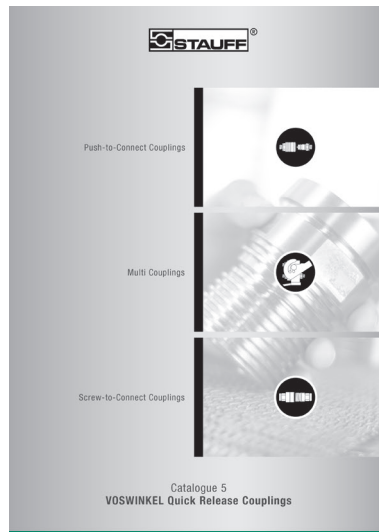

**Catalogue 5
VOSWINKEL
Quick Release Couplings**

- Push-to-Connect Couplings
- Multi Couplings
- Screw-to-Connect Couplings



**Catalogue 6
STAUFF Valves**

- Two-Way Ball Valves
- Multi-Way Ball Valves
- Flow Control and Check Valves
- Gauge Isolator Valves





Catalogue 7 STAUFF Test

- Test Couplings
- Test Adaptors
- Test Hoses and Connectors



Catalogue 8 STAUFF Diagtronics

- Pressure Gauges
- Hydraulic Testers
- Oil Analysis Equipment



Catalogue 9 STAUFF Filtration Technology

- Replacement Filter Elements
- Pressure Filters
- Return-Line Filters
- In-Line Filters
- Spin-On Filters
- Offline and Bypass Filters
- Filtration Systems

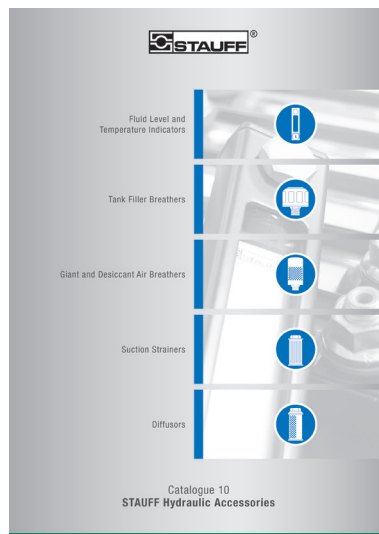

Catalogue 10 STAUFF Hydraulic Accessories

- Fluid Level and Temperature Indicators
- Tank Filler Breathers
- Giant and Desiccant Air Breathers
- Suction Strainers
- Diffusors



For more than 50 years, the companies of STAUFF Group have been developing, manufacturing and distributing pipework equipment and hydraulic components for mechanical and plant engineering and for service and industrial maintenance.

In addition to mobile and industrial hydraulic machinery, typical applications also include commercial and special purpose vehicles, rail transportation and energy technology. Likewise, STAUFF products are used in marine, oil and gas applications and in the process, food and chemical industries.

The overall range currently includes about 40000 standard products as well as numerous special and system solutions according to customer's specifications or based on our in-house development.

All STAUFF products undergo relevant testing in accordance with international regulations and are governed by the high standards of the in-house quality management system. Furthermore, many items have received certifications and approvals from various international institutes, organisations and authorities who have independently confirmed the quality and performance of the products.

Wholly-owned manufacturing, sales and service facilities in 18 countries and a tight global network of authorised distribution partners ensure high presence and service paired with a maximum of availability.



Quality Management – ISO 9001:2015
Environmental Management – ISO 14001:2015
Safety Management OHSAS – 18001:2007

STAUFF LINE Components

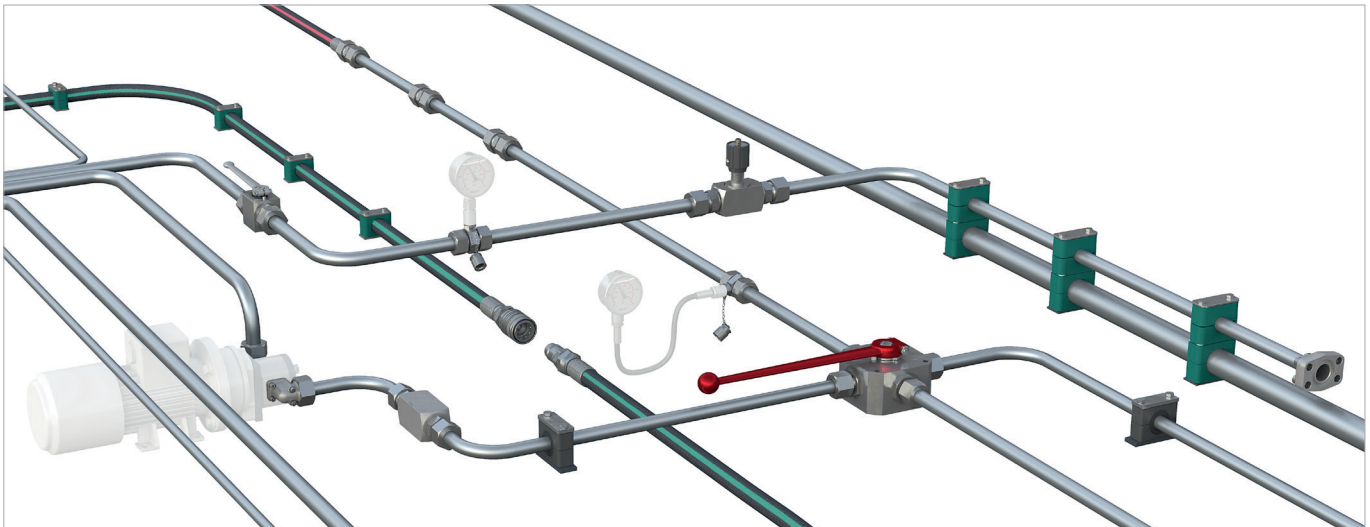

With the seven dedicated **STAUFF Line** product groups

- **STAUFF Clamps**
- **STAUFF Connect**
- **STAUFF Flanges**
- **VOSWINKEL Hose Connectors**
- **VOSWINKEL Quick Release Couplings**
- **STAUFF Valves**
- **STAUFF Test**

from own, in-house development and manufacturing, the companies of the STAUFF Group provide a comprehensive range of components for fastening and connecting pipes, tubes and hoses for mobile and industrial hydraulic applications and many other industries.

The portfolio is completed by components for shutting-off, regulating, throttling and measuring fluid media.

In order to perfectly match each other, STAUFF Line products are designed and offered on a high, uniform level of quality. A large proportion of the range made from steel comes as standard with the premium STAUFF Zinc/Nickel surface coating, which is also optionally available for many of the other components.

This coating offers the most reliable surface protection far beyond the previous market standards – even after transport, handling and assembly of the components – and meets all current legal requirements.

If desired, Original Equipment Manufacturers can be supported with value-added services, from **technical consultation to pre-assembly, assembly and kitting** as well as **logistics services**:

- Support with the **selection of suitable standard components** and ordering options; provision of **customised solutions** according to customer's specifications or based on our in-house development – from prototyping to large scale production
- **Analysis and optimization** of existing and design and developments of new systems aimed at increasing the efficiency and performance of machines and equipment and creating value for customers by reducing the total cost
- **Pre-assembly, assembly and kitting** of individual components to customer-specific system modules
- Individually coordinated **procurement solutions** (e.g. web shop and electronic data interchange) and **supply models** (e.g. from warehousing of customised components to Kanban logistics and just-in-time delivery of pre-fabricated system modules to the assembly lines of the customers) aimed at optimising material flows



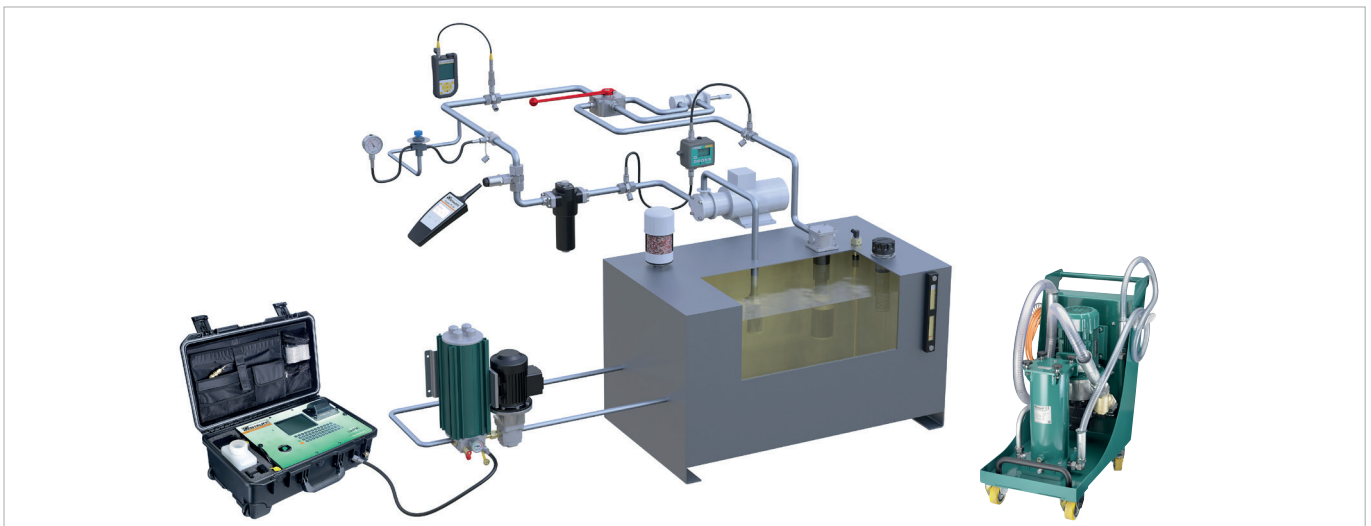

Aligned with the needs of the market, the product groups

- **STAUFF Test**
- **STAUFF Diagtronics**
- **STAUFF Filtration Technology**
- **STAUFF Hydraulic Accessories**

include a comprehensive range of analogue and digital measuring equipment and devices, filtration systems and replacement filter elements as well as accessories for the construction of tanks, reservoirs, power packs and gear boxes in mobile and industrial hydraulics.

The offer is completed by relevant value-added services:

- Support with the **selection of suitable components** and ordering options; provision of **customised solutions** according to customer's specifications or based on our in-house development – from prototyping to large scale production
- Analysis of existing hydraulic circuits aimed at filtration systems, tank components and monitoring devices that perfectly match to the specific requirements, and developing integrated concepts to increase the efficiency and performance of machines and equipment
- Individually coordinated **procurement solutions** and **supply models**





STAUFF Diagtronics

With measuring, testing, display and analysis devices and equipment from the STAUFF Diagtronics product range, system operators, maintenance personnel and repair technicians can determine and monitor the essential parameters in mobile and industrial hydraulics: operating pressure, maximum pressure, differential pressure, system temperature, volume flow, contamination and much more.

The range includes analogue and digital pressure gauges, that are either supplied individually or as part of practical pressure test kits including the required connection adaptors and accessories, as well as high-performance hand-held hydraulic testers of the PPC series, that have been developed to meet the growing demands of the industry.

The PT-RF series of pressure transmitters and readers are an alternative solution for universal pressure measurements for fluid technology applications. The advantages resulting from the use of the non-contact RFID technology for system operators, maintenance personnel and repair technicians are clear: Measurements can be carried very easily, without extensive training and within a few seconds at the press of a button and then documented in a reliable process – while temporary opening of the system if not required. Potential hazards for people, machines and the environment as well as ingress of contamination into the system can be effectively excluded.

Fluid analysis is a crucial element of any oil management program. Early detection of system contamination can prevent costly repairs and downtime.

Portable and permanently installed STAUFF particle counters and monitors enable the precise determination of cleanliness levels of hydraulic media according to international standards.







www.stauff.com/catalogues

The STAUFF online catalogue centre at www.stauff.com/catalogues provides fast and direct access to digital versions of this as well as other STAUFF product catalogues in all available languages.

Online Page-Flip Catalogues

- Easy navigation through index or the powerful full text search functionality
- Contents can be shared and forwarded by e-mail, printed or downloaded and saved in PDF file format
- Also suitable for mobile devices

Download Catalogues

- Download entire product catalogues and save them in PDF file format

Catalogue Request

- Contact form to request printed copies of the product catalogue as well as digital copies on CD-ROM or USB stick

The fastest way to the online page-flip catalogue:

The links that can be found at the bottom edge of all pages of this product catalogue will lead you directly to the corresponding page in the online page-flip catalogue.

In doing so, contents can be searched, shared and forwarded by e-mail, printed or downloaded and saved in PDF file format.

Scan the QR code next to the direct link with the camera of your mobile device* and also use the functions in this way.

* may require a suitable app



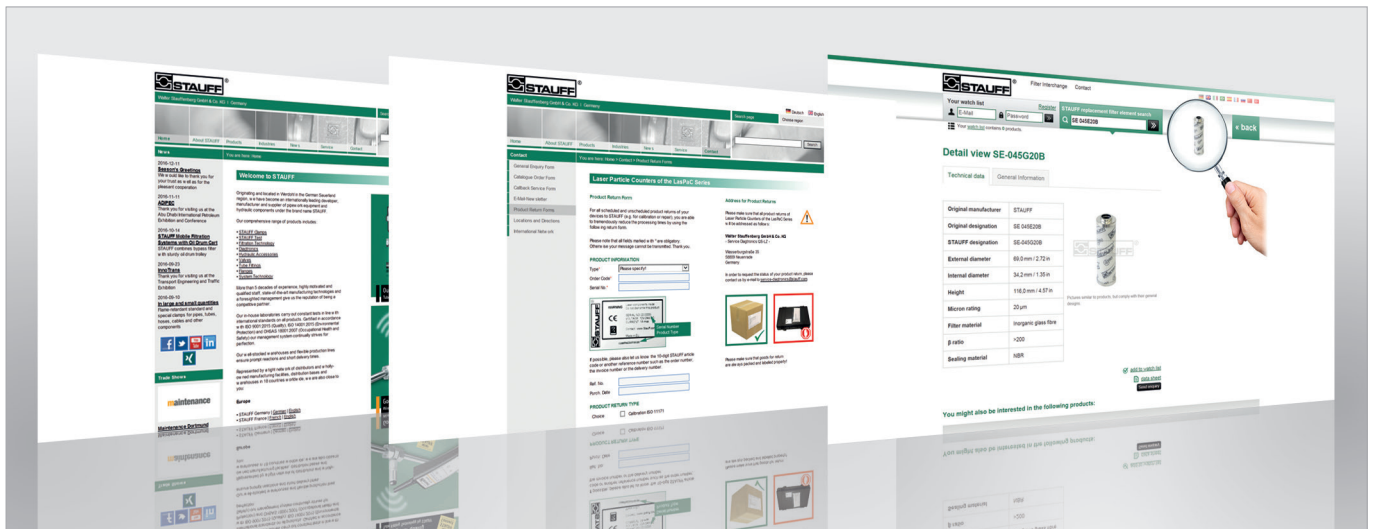

www.stauff.com

General information about the companies of STAUFF Group, latest business and product news as well as complete global contact details

www.stauff.com/service-diagtronics

Comfortable pre-registration for scheduled and unscheduled product returns of your measuring, testing and analysis devices to STAUFF, e.g. for calibration or service

www.filterinterchange.com

Online database for the quick and easy identification and interchange of almost all common brands and types of replacement filter elements

Follow STAUFF and keep yourself updated:

- 

Facebook
www.facebook.com/stauffgroup
- 





Twitter
www.twitter.com/stauffgroup
- 

LinkedIn
www.linkedin.com/company/stauff
- 

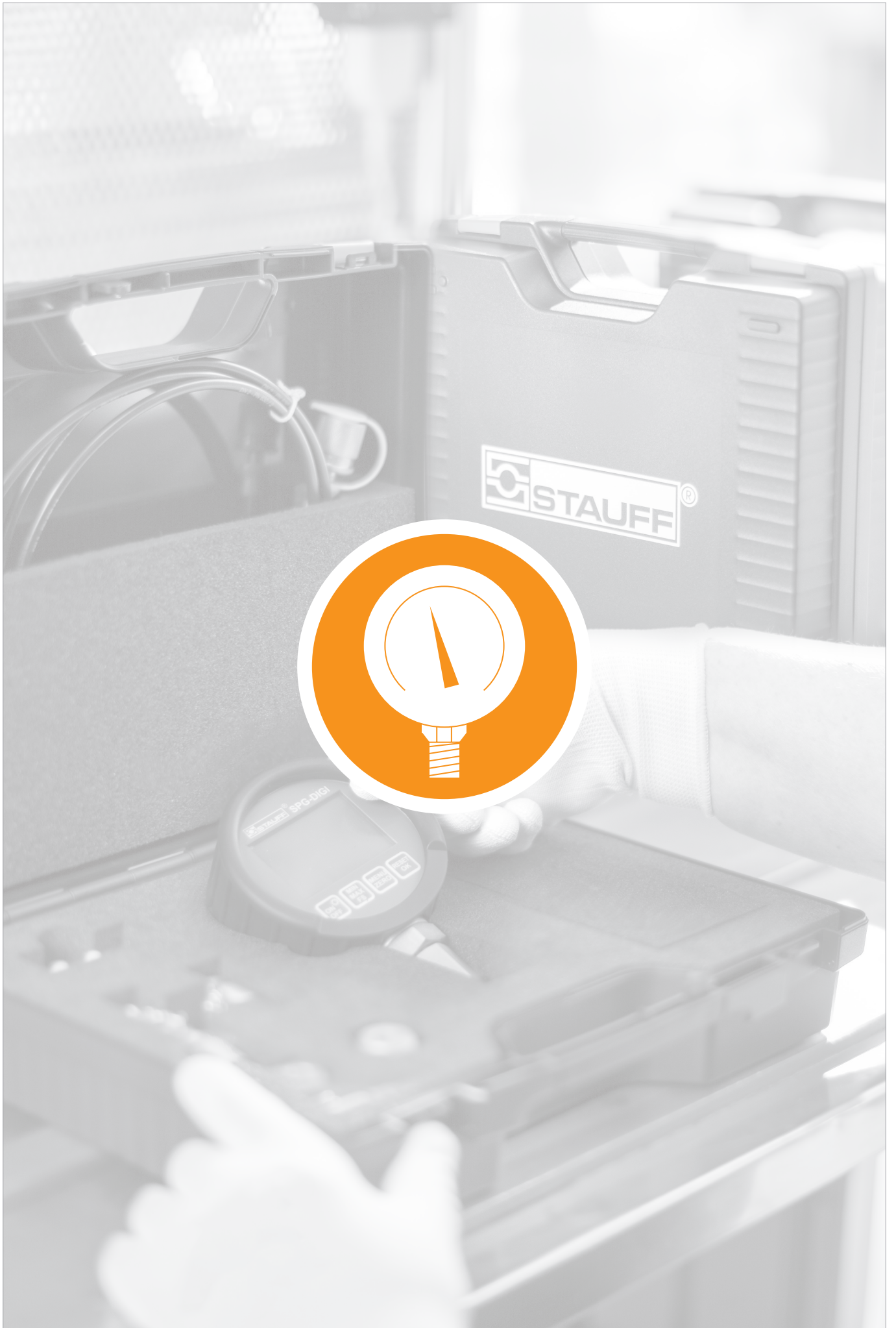
Youtube
www.youtube.com/stauffgroup





Introduction	14
Information on the Pressure Equipment Directive	15
Accessories for Pressure Gauges	15
Pressure Gauges	16 - 21
 Analogue Pressure Gauge	16 - 17
SPG	
 Analogue Pressure Test Kit	18 - 19
SMB-20 / SMB-15	
 Digital Pressure Gauge	20
SPG-DIGI	
 Digital Pressure Test Kit	21
SMB-DIGI	



Pressure Gauges (analogue/digital) and Accessories

A



Measuring pressure on equipment is indispensable for monitoring and ensuring the smooth functioning and operating safety of these systems.

STAUFF offers a variety of simple pressure measuring devices for liquid and gaseous media. These pressure gauges can be used as both stationary or portable devices. STAUFF addresses the very extensive width of possible system pressures and the strict requirements for precision with a variety of pressure gauge types with different measuring ranges.

The glycerine filled gauge range is available with various connection ports to fit many different installation needs. The pressure gauges can be purchased alone or in a test kit. The kits can be supplied with gauges with different pressure ranges and adaptors to satisfy any requirement.

The analog pressure gauges are primarily designed for permanent installations. STAUFF also offers a digital line for analytical troubleshooting.

These digital pressure gauges are also available as a pressure test kit and also make it possible to perform the many different measurement tasks with the help of adaptors and the measuring hose. An important advantage is the possibility to measure pressure peaks with the device, to save them short term and to display them in the display as MIN and MAX values.

In addition to the individual products, the STAUFF measuring devices are also available as kit.



Information on the Pressure Equipment Directive (PED) 97/23/EC Pressure Equipment Directive (PED)

Our pressure gauges (SPG) conform to the European Standard EN 837-1 and are manufactured and tested according to appropriate requirements. Pressure gauges with a full scale value between 0,5 bar and 200 bar / 7.25 PSI and 2900 PSI come under „Good Engineering Practice“ and must not carry a CE mark (section 3, paragraph 3).

Pressure gauges (SPG) with a full scale value of less than 0,5 bar / 7.25 PSI and loose diaphragm sealings do not come under the PED and must not carry a CE mark. Our pressure gauges (SPG) with a full scale value of > 200 bar / 2900 PSI receive a CE mark according to the conformity procedure.

The CE mark is attached to the outside of the housing (type designation plate).
We are not authorised to CE mark pressure gauges without a company name or a company logo.



A

Pressure Gauges ▀ Accessories



Single Station Gauge Isolator Valve
(see Catalogue 6 - STAUFF Valves)



Multi Station Gauge Isolator Valve
(see Catalogue 6 - STAUFF Valves)

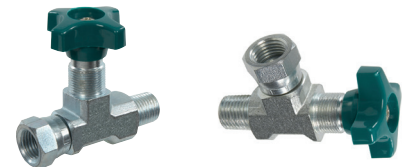

Gauge Isolator Needle Valves
(see Catalogue 6 - STAUFF Valves)



Test Hoses - Gauge Adaptor
(see Catalogue 7 - STAUFF Test)



Gauge Adaptor
(see Catalogue 7 - STAUFF Test)



Direct Gauge Adaptor
(see Catalogue 7 - STAUFF Test)



Adjustable Gauge Fitting
(see Catalogue 7 - STAUFF Test)



Pressure Gauge (analogue) - Type SPG

A



Pressure Gauge (Analogue) Type SPG (Stem Mounting)



Pressure Gauge (Analogue) Type SPG (Panel Mounting)

Product Description

Area of Application

- Mechanical pressure measurement

Features

- Suitable for hydraulic oil and gaseous media compatible with copper based alloys
- Available in nominal sizes 63 and 100 mm / 2.5 and 4 in
- Thread form: for BSP (G1/4 and G1/2), NPT (1/4 NPT and 1/2 NPT), SAE (7/16–20 UNF)
- Stainless Steel (1.4301) housing
- Acrylic sight glass
- Glycerine filled
- Standard dual scales with pressure indication in bar and PSI
- U-bolt or flange mounting kit on request

Note: Please contact STAUFF before you use SPG with other media.

Options

- Protective rubber cap
- Additional scale readings including personalisation
- U-bolt and flange mounting kits are available separately as spare parts

Technical Data

- Pressure gauge according to EN 837-1
- Subject to technical modifications

Accuracies

SPG-063:	1.6 (± 1.6 % FS* as per EN 837-1)
SPG-100:	1.0 (± 1.0 % FS* as per EN 837-1)

Permissible Temperatures

- Ambient: -20 °C ... +60 °C / -4 °F ... +140 °F
- Media: max. +60 °C / max. +140 °F

Protection Ratings

- IP 65: for all manometer SPG-100 and SPG-063 > 16 bar / 232 PSI
IP 65 protection rating: Dust tight and protected against water jets for all manometer SPG-063 ≤ 16 bar / 232 PSI due to pressure compensation opening
- IP 54: IP 54 protection rating: Dust protected and protected against splashing water

Order Codes

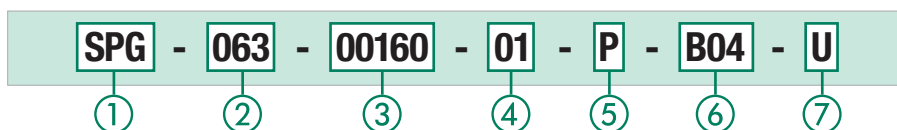

① Series and Type

Stainless Steel Pressure Gauge	SPG
--------------------------------	------------

② Size

Ø 63 mm, with G1/4 or 1/4 NPT connection	063
Ø 100 mm, with G1/2 or 1/2 NPT connection	100

③ Pressure Ranges

Pressure Ranges for style of scale 01 - bar/PSI	Code	Pressure Ranges for style of scale 05 - PSI/bar	Code
-1 ... 1,5 bar / -14,5 ... 21 PSI	(-00001)-00001.5	-1,02 ... 0 bar / -30 inHg ... 0 PSI	30HG30
-1 ... 3 bar / -14,5 ... 43 PSI	(-00001)-00003	-1,02 ... 2,07 bar / -30 inHg ... 30 PSI	03030
0 ... 10 bar / 0 ... 145 PSI	00010	0 ... 2,07 bar / 0 ... 30 PSI	00030
0 ... 16 bar / 0 ... 232 PSI	00016	0 ... 4,14 bar / 0 ... 60 PSI	00060
0 ... 25 bar / 0 ... 362 PSI	00025	0 ... 6,89 bar / 0 ... 100 PSI	00100
0 ... 40 bar / 0 ... 580 PSI	00040	0 ... 11,03 bar / 0 ... 160 PSI	00160
0 ... 60 bar / 0 ... 870 PSI	00060	0 ... 13,79 bar / 0 ... 200 PSI	00200
0 ... 100 bar / 0 ... 1450 PSI	00100	0 ... 20,68 bar / 0 ... 300 PSI	00300
0 ... 160 bar / 0 ... 2320 PSI	00160	0 ... 34,74 bar / 0 ... 500 PSI	00500
0 ... 250 bar / 0 ... 3625 PSI	00250	0 ... 41,37 bar / 0 ... 600 PSI	00600
0 ... 400 bar / 0 ... 5801 PSI	00400	0 ... 68,95 bar / 0 ... 1000 PSI	01000
0 ... 600 bar / 0 ... 8702 PSI	00600	0 ... 103,42 bar / 0 ... 1500 PSI	01500
0 ... 680 bar / 0 ... 9862 PSI	00680	0 ... 137,90 bar / 0 ... 2000 PSI	02000
0 ... 700 bar / 0 ... 10152 PSI	00700	0 ... 206,84 bar / 0 ... 3000 PSI	03000
0 ... 1000 bar / 0 ... 14503 PSI	01000	0 ... 275,79 bar / 0 ... 4000 PSI	04000
		0 ... 344,74 bar / 0 ... 5000 PSI	05000
		0 ... 413,69 bar / 0 ... 6000 PSI	06000
		0 ... 517,11 bar / 0 ... 7500 PSI	07500
		0 ... 689,48 bar / 0 ... 10000 PSI	10000

Note: Others on request. Information always refer to the pressure setting of the outside scale.

④ Styles of Scales

bar / PSI (bar outside/PSI inside - standard option Europe)	01
bar	02
PSI	03
PSI / bar (PSI outside/ bar inside - standard option North America)	05
kPa / PSI (kPa outside/ PSI inside)	10

Note: Others on request.

⑤ Adaption

Stem mounting	S
Panel mounting	P

⑥ Process Connection

G1/4 (only SPG-063)	B04
G1/2 (only SPG-100)	B08
1/4 NPT (only SPG-063)	N04
1/2 NPT (only SPG-100)	N08
7/16–20 UNF (only SPG-063)	U04

Note: Others on request.

⑦ Accessories

No accessory	(none)
U-bolt assembly	U
Front flange assembly (for panel mount only)	F
Rear flange assembly	R
U-bolt and front flange assembly (for panel mount only)	UF
Protective rubber cap (for stem mount only)	G

For further information see Catalogue 7 - STAUFF Test.

* FS = Full Scale



Pressure Gauge (analogue) ▪ Type SPG

A

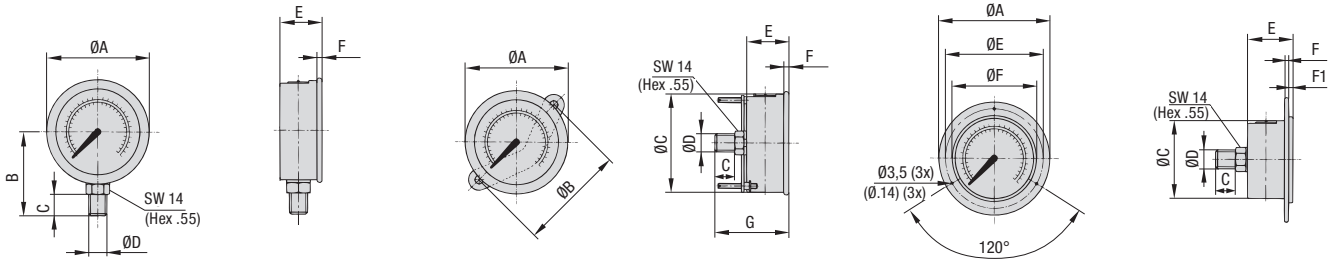

SPG-063 ... S ...

SPG-063 ... P ... U

SPG-063 ... P ... F

Dimensions SPG-063

Version Pressure Gauge	Dimension (mm/in)											
	ØA	ØB	ØC	ØD	ØE	ØF	B	C	E	F	F1	G
SPG-063	69	-	-	G1/4	-	-	54	15	32	6,5	-	-
	2.72	-	-	1/4 NPT	-	-	2.13	.59	1.26	.26	-	-
				7/16-20 UNF								
SPG-063 ... U	69	72	62	G1/4	-	-	-	15	32	6,5	-	56
	2.72	2.83	2.44	1/4 NPT	-	-	-	.59	1.26	.26	-	2.20
				7/16-20 UNF								
SPG-063 ... F	85	-	62	G1/4	75	68	-	15	32	1	6,5	-
	3.35	-	2.44	1/4 NPT	2.95	2.68	-	.59	1.26	.04	.26	-
				7/16-20 UNF								

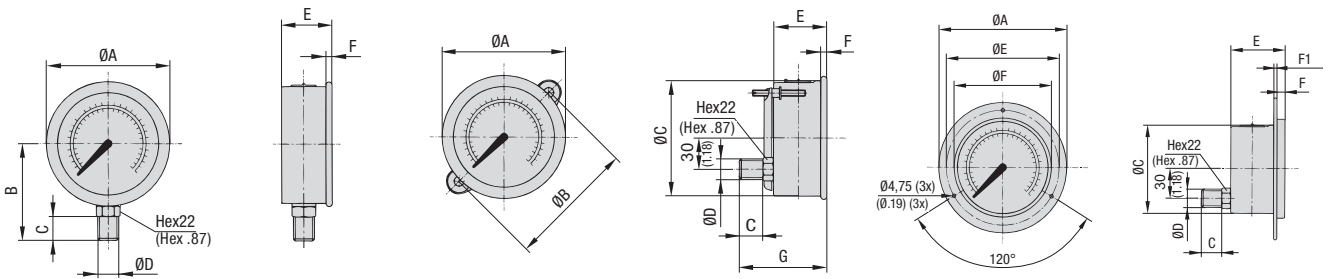

SPG-100 ... S ...

SPG-100 ... P ... U

SPG-100 ... P ... F

Dimensions SPG-100

Version Pressure Gauge	Dimension (mm/in)											
	ØA	ØB	ØC	ØD	ØE	ØF	B	C	E	F	F1	G
SPG-100	107	-	-	G1/2	-	-	87	23	48	8	-	-
	4.21	-	-	1/2 NPT	-	-	3.43	.91	1.89	.31	-	-
SPG-100 ... U	107	107	100	G1/2	-	-	-	23	48	8	-	81,5
	4.21	4.21	3.94	1/2 NPT	-	-	-	.91	1.89	.31	-	3.21
SPG-100 ... F	132	-	100	G1/2	116	107	-	23	48	8	1,25	-
	5.20	-	3.94	1/2 NPT	4.57	4.21	-	.91	1.89	.31	.05	-

* FS = Full Scale

Dimensional drawings: All dimensions in mm (in).



Pressure Test Kit (analogue) ▪ Type SMB-20 / SMB-15

A



Pressure test kit (analogue) with SPG-063 (3x) Pressure test kit (analogue) with SPG-100 (1x)

Product Description

In addition to the individual SPG gauges, the STAUFF Pressure Gauges are also available as part of a pressure test kit.

The SMB Pressure Test Kits are assembled in various versions, in accordance with customer wishes. All pressure test kits are supplied in a handy case with custom-designed foam inserts.

Custom kits available upon request. Please contact STAUFF.

Please see on page 19 for standard options.

Order Codes

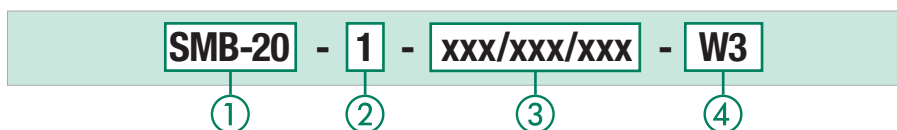

① Series and Type

Pressure Test Kit, analogue (STAUFF Test 20)	SMB-20
Pressure Test Kit, analogue (STAUFF Test 15)	SMB-15

② Number of Pressure Gauges

1 pressure gauge SPG-063	1
2 pressure gauges SPG-063	2
3 pressure gauges SPG-063	3
1 pressure gauge SPG-100	/100-1

③ Pressure Ranges

-1 ... 3 bar / -14.5 ... 43 PSI	(-1)-003
0 ... 10 bar / 0 ... 145 PSI	010
0 ... 16 bar / 0 ... 232 PSI	016
0 ... 25 bar / 0 ... 362 PSI	025
0 ... 40 bar / 0 ... 580 PSI	040
0 ... 60 bar / 0 ... 870 PSI	060
0 ... 100 bar / 0 ... 1450 PSI	100
0 ... 160 bar / 0 ... 2320 PSI	160
0 ... 250 bar / 0 ... 3625 PSI	250
0 ... 400 bar / 0 ... 5801 PSI	400

Note: Please indicate pressure ranges in bar.
 For one pressure gauge please replace xxx.
 For two pressure gauges please replace xxx/xxx.
 For three pressure gauges please replace xxx/xxx/xxx.

④ Material Surface

Steel, zinc/nickel plated	W3
---------------------------	-----------

For further information see Catalogue 7 - STAUFF Test.



Standard Option for Pressure Test Kits (analogue) ▪ Type SMB-20 / SMB-15

Series	Components	Order Codes	Series	Components	Order Codes
SMB-20-1-xxx-W3	1x Test hose (2000 mm length)	SMS-20-2000-B-W3	SMB-15-1-xxx-W3	1x Test hose (2000 mm length)	SMS-15-2000-B-W3
	1x Pressure gauge Ø 63 mm	SPG-063-xxx-...		1x Pressure gauge Ø 63 mm	SPG-063-xxx-...
	1x Gauge adaptor G1/4	SMA-20-G1/4-B-OR-W3		1x Gauge adaptor G1/4	SMA-15-G1/4-B-OR-W3
	1x Direct gauge adaptor G1/4	SMD-20-G1/4-B-OR-W3		1x Direct gauge adaptor G1/4	SMD-15-G1/4-B-OR-W3
	1x Test coupling G1/4	SMK-20-G1/4-B-C-W3		1x Test coupling G1/4	SMK-15-G1/4-B-B-W3
	1x Test coupling M10 x 1	SMK-20-M10x1-B-A-W3		1x Test coupling M14 x 1,5	SMK-15-M14x1.5-B-B-W3
	1x Thread adaptor G3/8	SRS-20-G3/8-B-W3		1x Thread adaptor G3/8	SRS-15-G3/8-B-W3
	1x Thread adaptor G1/2	SRS-20-G1/2-B-W3		1x Thread adaptor G1/2	SRS-15-G1/2-B-W3

xxx/xxx/xxx = pressure ranges see on page 18 (please indicate pressure ranges in bar)
Custom kits available upon request. Please contact STAUFF.

Series	Components	Order Codes	Series	Components	Order Codes
SMB-20-2-xxx/xxx-W3	1x Test hose (2000 mm length)	SMS-20-2000-B-W3	SMB-15-2-xxx/xxx-W3	1x Test hose (2000 mm length)	SMS-15-2000-B-W3
	2x Pressure gauges Ø 63 mm	SPG-063-xxx-...		2x Pressure gauges Ø 63 mm	SPG-063-xxx-...
	1x Gauge adaptor G1/4	SMA-20-G1/4-B-OR-W3		1x Gauge adaptor G1/4	SMA-15-G1/4-B-OR-W3
	1x Direct gauge adaptor G1/4	SMD-20-G1/4-B-OR-W3		1x Direct gauge adaptor G1/4	SMD-15-G1/4-B-OR-W3
	1x Test coupling G1/4	SMK-20-G1/4-B-C-W3		1x Test coupling G1/4	SMK-15-G1/4-B-B-W3
	1x Test coupling M10 x 1	SMK-20-M10x1-B-A-W3		1x Test coupling M14 x 1,5	SMK-15-M14x1.5-B-B-W3
	1x Thread adaptor G3/8	SRS-20-G3/8-B-W3		1x Thread adaptor G3/8	SRS-15-G3/8-B-W3
	1x Thread adaptor G1/2	SRS-20-G1/2-B-W3		1x Thread adaptor G1/2	SRS-15-G1/2-B-W3

xxx/xxx/xxx = pressure ranges see on page 18 (please indicate pressure ranges in bar)
Custom kits available upon request. Please contact STAUFF.

Series	Components	Order Codes	Series	Components	Order Codes
SMB-20-3-xxx/xxx/xxx-W3	2x Test hoses (2000 mm length)	SMS-20-2000-B-W3	SMB-15-3-xxx/xxx/xxx-W3	2x Test hoses (2000 mm length)	SMS-15-2000-B-W3
	3x Pressure gauges Ø 63 mm	SPG-063-xxx-...		3x Pressure gauges Ø 63 mm	SPG-063-xxx-...
	1x Gauge adaptor G1/4	SMA-20-G1/4-B-OR-W3		1x Gauge adaptor G1/4	SMA-15-G1/4-B-OR-W3
	2x Direct gauge adaptors G1/4	SMD-20-G1/4-B-OR-W3		2x Direct gauge adaptors G1/4	SMD-15-G1/4-B-OR-W3
	3x Test couplings G1/4	SMK-20-G1/4-B-C-W3		3x Test couplings G1/4	SMK-15-G1/4-B-B-W3
	3x Test couplings M10 x 1	SMK-20-M10x1-B-A-W3		3x Test couplings M14 x 1,5	SMK-15-M14x1.5-B-B-W3
	1x Thread adaptor G3/8	SRS-20-G3/8-B-W3		1x Thread adaptor G3/8	SRS-15-G3/8-B-W3
	1x Thread adaptor G1/2	SRS-20-G1/2-B-W3		1x Thread adaptor G1/2	SRS-15-G1/2-B-W3

xxx/xxx/xxx = pressure ranges see on page 18 (please indicate pressure ranges in bar)
Custom kits available upon request. Please contact STAUFF.

Series	Components	Order Codes	Series	Components	Order Codes
SMB-20/100-1-xxx-W3	1x Test hose (2000 mm length)	SMS-20-2000-B-W3	SMB-15/100-1-xxx-W3	1x Test hose (2000 mm length)	SMS-15-2000-B-W3
	1x Pressure gauge Ø 100 mm	SPG-100-xxx-...		1x Pressure gauge Ø 100 mm	SPG-100-xxx-...
	1x Gauge adaptor G1/2	SMA-20-G1/2-B-OR-W3		1x Gauge adaptor G1/2	SMA-15-G1/2-B-OR-W3
	1x Direct gauge adaptor G1/2	SMD-20-G1/2-B-OR-W3		1x Direct gauge adaptor G1/2	SMD-15-G1/2-B-OR-W3
	1x Test coupling G1/2	SMK-20-G1/2-B-C-W3		1x Test coupling G1/4	SMK-15-G1/4-B-B-W3
	1x Test coupling M10 x 1	SMK-20-M10x1-B-A-W3		1x Test coupling M14 x 1,5	SMK-15-M14x1.5-B-B-W3
	1x Thread adaptor G3/8	SRS-20-G3/8-B-W3		1x Thread adaptor G3/8	SRS-15-G3/8-B-W3
	1x Thread adaptor G1/2	SRS-20-G1/2-B-W3		1x Thread adaptor G1/2	SRS-15-G1/2-B-W3

xxx/xxx/xxx = pressure ranges see on page 18 (please indicate pressure ranges in bar)
Custom kits available upon request. Please contact STAUFF.

Accessories (Connection Adaptors)

Adaptor	Adaption from	to Dimension G
SDA-20-G1/4-W3	G1/4	M16 x 2
SDA-15-G1/4-W3	G1/4	M16 x 1,5
SDA-12-G1/4-W3	G1/4	S12,65 x 1,5
SAD-20/15-B-W3	M16 x 2	M16 x 1,5
SAD-20/12-B-W3	M16 x 2	S12,65 x 1,5
SAD-20/10-B-W3	M16 x 2	Plug-in system

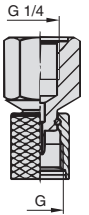

SDA adaptor
Connects the pressure gauge to a test coupling



SAD adaptor
Only in conjunction with the SDA-20-G1/4-W3 adaptor, connects to other test coupling sizes

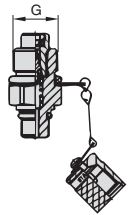

Test coupling
STAUFF Test or comparable

Other adaptors are available.



Digital Pressure Gauge ▪ Type SPG-DIGI



Product Description

The SPG-DIGI Digital Pressure Gauges are intended to measure and display pressures in hydraulic systems, particularly for oils, lubricants and water. They can display the current measured values, as well as minimum and maximum values, with an accuracy of 0,5 % of full scale.

The SPG-DIGI Digital Pressure Gauges are available individually, or as part of a complete pressure test kit. They are very sturdy, reliable, easy to use and come with the CE mark (evidence of conformity compliance).

Features

- Bar graph display (drag indicator)
- Background lighting
- Zero correction
- Battery charge display

Order Codes



① Series and Type

Digital Pressure Gauge **SPG-DIGI**

② Pressure Ranges

-1 ... 16 bar / -14.5 ... 232 PSI	B0016
0 ... 100 bar / 0 ... 1450 PSI	B0100
0 ... 400 bar / 0 ... 5801 PSI	B0400
0 ... 600 bar / 0 ... 8702 PSI	B0600

③ Process Connection

G1/4	B
7/16–20 UNF	U

④ Calibration

Without calibration certificate	(none)
With calibration certificate	CAL

Pressure Ranges

Version	Pressure Range (bar/PSI)	Maximum Pressure (bar/PSI)	Burst Pressure (bar/PSI)
B0016	-1 ... 16	40	50
	-14.5 ... 232	580	725
B0100	0 ... 100	200	800
	0 ... 1450	2900	11603
B0400	0 ... 400	800	1700
	0 ... 5801	11603	24656
B0600	0 ... 600	1200	2200
	0 ... 8702	17404	31908

Technical Data

Materials

- Housing made of die-cast Zinc with TPE rubber protective covering
- Wetted parts: Stainless Steel 1.4404, NBR, ceramic
- Gaskets: NBR (Buna-N®) FKM (Viton®) or EPDM upon request

Dimensions and Weight

- Diameter: 79 mm / 3.11 in
- Depth: 33 mm / 1.30 in
- Weight: 540 g / 1.19 lbs

Display

- Text display 4 1/2-digit
- Size: 50 x 34 mm / 1.97 x 1.34 in
- Actual value display: 15 mm / .59 in
- MIN-/MAX or FS* display: 8 mm / .31 in
- Units: bar, PSI, Mpa, kPa, mbar
- Peak pressure measurement with 10 ms sampling rate
- Lighted measured value display

Accuracy

- ±0,25 % FS* typ. / ±0,5 % FS* max.
- Resolution: 4096 steps

Permissible Temperatures

- Ambient: -10 °C ... +50 °C / +14 °F ... +122 °F
- Media: -20 °C ... +80 °C / -4 °F ... +176 °F
- Storage: -20 °C ... +60 °C / -4 °F ... +140 °F

- Relative humidity: < 85 %
- Battery life: max. 1500 hours (operating without lighting, 2 x 1,5 V DC AA (LR6-AA) Alkaline Mignon)

Process Connections

- G1/4 or 7/16–20 UNF made of 1.4404 Stainless Steel

- Vibration: IEC 60068-2-6 / 10 ... 500 Hz / 5 g
- Shock: IEC 60068-2-27 / 11 ms / 25 g
- Load cycles (10⁶): 100

Protection Rating

- IP 67 protection rating: Dust tight and protected against powerful water jets; even immersion (up to 1 m / 3.28 ft) in water is possible under defined conditions of pressure and time

* FS = Full Scale



Pressure Test Kit (digital) ▪ Type SMB-DIGI
A

Pressure Test Kit (Digital) Type SMB-DIGI

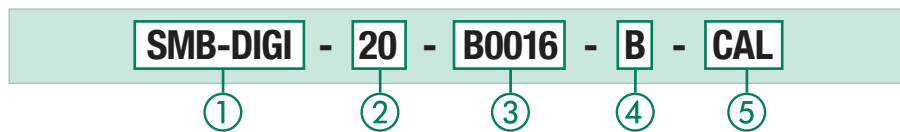
Order Codes

① Series and Type

 Pressure Test Kit, digital pressure gauge **SMB-DIGI**
② Adaptor Version

 Adapts to STAUFF Test 20 (M16 x 2) **20**
③ Pressure Ranges

-1 ... 16 bar / -14.5 ... 232 PSI	B0016
0 ... 100 bar / 0 ... 1450 PSI	B0100
0 ... 400 bar / 0 ... 5801 PSI	B0400
0 ... 600 bar / 0 ... 8702 PSI	B0600

④ Process Connection

G1/4	B
7/16-20 UNF	U

⑤ Calibration

Without calibration certificate	(none)
With calibration certificate	CAL

Product Description

In addition to the individual SPG-DIGI devices, the STAUFF Digital Pressure Gauges are also available as part of a pressure test kit.

The SMB-DIGI pressure test kits are assembled in various versions, in accordance with customer wishes. All pressure test kits are supplied in a handy case with custom-designed foam inserts.

Components
Standard Option SMB-DIGI-20

- Digital Pressure Gauge SPG-DIGI
- Test Hose (2 m / 6.56 ft), M16 x 2, pressure-resistant 600 bar (8702 PSI) SMS-20-2000-B-W3
- Adaptor SDA (G1/4 to M16 x 2) SDA-20-G1/4-W3
- Hose Connector SSV-20-W3
- Test Coupling SMK-20-G1/4-B-C-W3
- Test Coupling SMK-20-M10x1-B-A-W3
- Thread Adaptor SRS-20-G3/8-B-W3
- Thread Adaptor SRS-20-G1/2-B-W3
- Operating manual (multilingual) on CD

Pressure Ranges

Version	Pressure Range (bar/PSI)	Maximum Pressure (bar/PSI)	Burst Pressure (bar/PSI)
B0016	-1 ... 16	40	50
	-14.5 ... 232	580	725
B0100	0 ... 100	200	800
	0 ... 1450	2900	11603
B0400	0 ... 400	800	1700
	0 ... 5801	11603	24656
B0600	0 ... 600	1200	2200
	0 ... 8702	17404	31908

Accessories (Connection Adaptors)

Adaptor	Adaption from	to Dimension G
SDA-20-G1/4-W3	G1/4	M16 x 2
SDA-15-G1/4-W3	G1/4	M16 x 1,5
SDA-12-G1/4-W3	G1/4	S12,65 x 1,5
SAD-20/15-B-W3	M16 x 2	M16 x 1,5
SAD-20/12-B-W3	M16 x 2	S12,65 x 1,5
SAD-20/10-B-W3	M16 x 2	Plug-in system

Other adaptors are available.





Introduction 25

Overview 26

Functional Block Diagrams 27

Hydraulic Testers 28 - 33

 PPC-04-plus
PPC-04-plus-CAN 28

 PPC-06/08-plus 29

 PPC-Pad 30 - 33

Pressure Sensors 34 - 35

 PPC-04/12-P 34

 PPC-CAN-P 35

Temperature Sensors 36 - 37















 PPC-04/12-T 36

 PPC-CAN-T 37

Pressure / Temperature Sensors 38 - 39

 PPC-04/12-PT 38

 PPC-CAN-PT 39

Flow Turbine		40 - 41	Pressure Transmitter		51 - 55
	PPC-04/12-SFM	40	Overview		51
	PPC-CAN-SFM	41		PT-RF	52
	Rotational Speed Sensor	42		Reader-PT-RF	53
	PPC-04/12-SDS-CAB		Complete Systems		54
	Current / Voltage / Frequency Converter	43		PT-RF-SET	
	Accessories	44		Accumulator Adaptor	55
				SBAA / SDAA	
	CAN Accessories	45	Flow Indicators		56 - 57
	CAN Frequency Converter	45		Flow Indicators	56 - 57
	PPC-CAN-FR			SDM / SDMCR	
Complete Systems		46 - 48			
	PPC-04/06/08-plus-SET	46			
	PPC-04-CAN-SET	47			
	PPC-Pad-SET	48			
Ordering Tables		49 - 50			
	For analogue Hydraulic Testers	49			
	For CAN Hydraulic Testers	50			

B

B

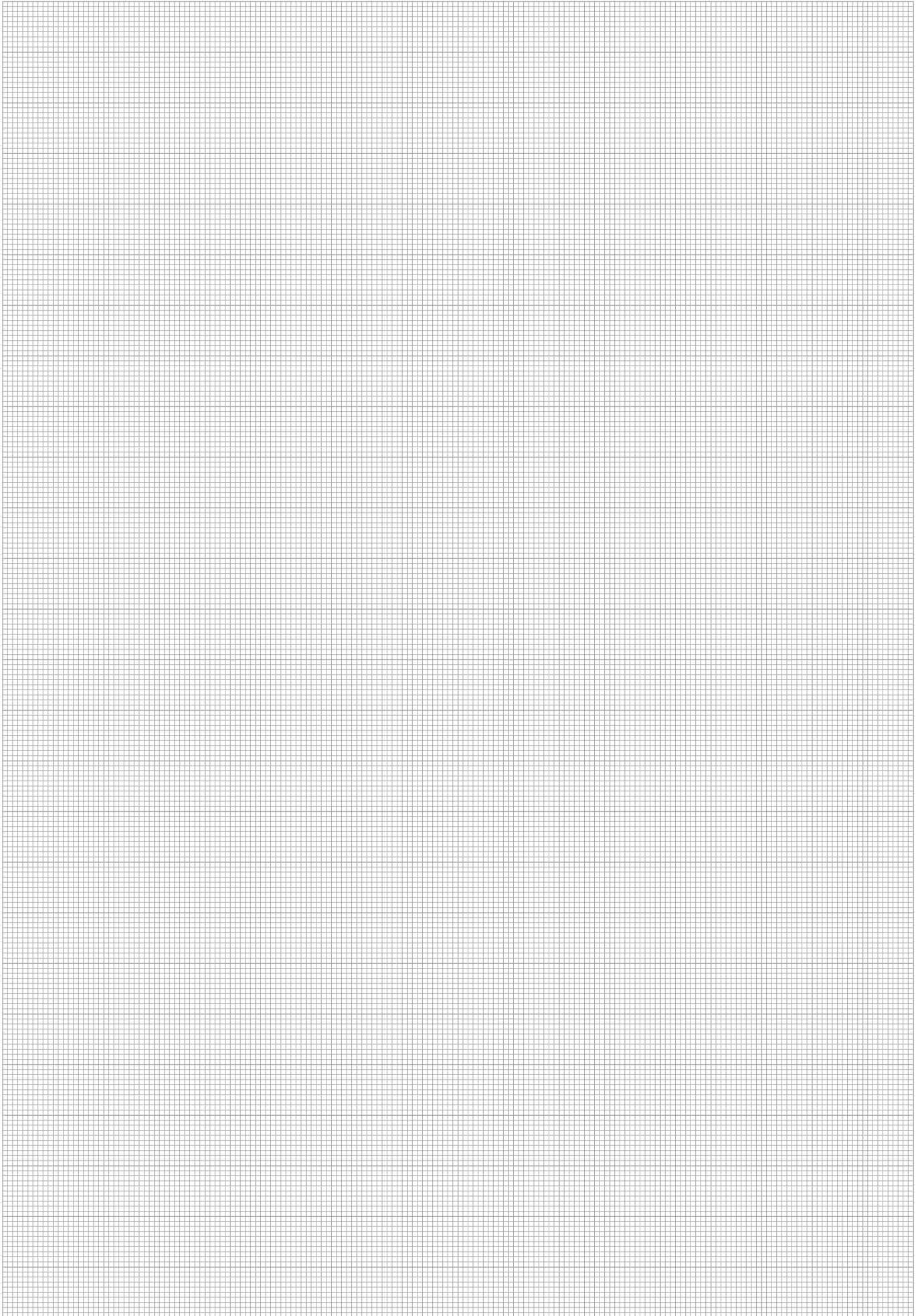



The STAUFF measuring and test equipment of the PPC series are perfectly suited for measuring all relevant parameters in fluid power systems, including pressure, differential pressure, temperature, flow and rotational speed.

Depending on the type, they allow evaluation, storage and further processing in PCs or notebooks. They have been especially developed for the growing needs of system monitoring, troubleshooting and determining measured values in hydraulic and pneumatic systems.

The application areas are broad:

- Industrial hydraulics
- Mobile, agricultural and forestry hydraulics
- Marine and offshore hydraulics
- Chemical and petrochemical industries
- Energy and air conditioning industries
- Heating and sanitary industries

Among other things, the latest generation of Hydraulic Tester PPC-04-plus is characterised by a simple operation. Even in low-light situations, measured values can be read quickly and reliably from the multi-line, backlit LCD display. The new Hydraulic Tester is available in two versions, either with two inputs for analogue sensors or with a CAN interface for connecting up to three digital sensors. Both versions are equipped with an internal data memory and an USB port. They are driven by an internal power supply (Lithium-Ion pack).

The Hydraulic Testers of the PPC-06/08-plus series, depending on the type, provide the potential of connecting three or four analogue sensors. Even older sensors of the STAUFF Diagtronics product program or third-party sensors can be used with these units without any problems. Both Hydraulic Testers are equipped with a large data memory and an integrated USB port, they can be used for several hours in battery operation. The included PC software allows to show the measured values as numerical values or as curve graphs on PCs or notebooks.

The PPC Pad is the highest-performance unit of the PPC series. This portable multi-function hand-held measuring instrument has been especially developed for the increasing fluid technology requirements. STAUFF's CAN bus sensors take advantage of the bus system's automatic sensor recognition to provide an easy-to-install Plug & Play solution. The measured values can be displayed in various presentation styles and make effective solutions-orientated analysis possible.

The Hydraulic Testers of the PPC series and their corresponding sensors are also available as calibrated version, they are delivered with a calibration certificate.

A subsequent calibration can be ordered by using a special order code.



Hydraulic Testers of the PPC Series - Product Overview

B

Hydraulic Testers					
Options	PPC-04-plus	PPC-04-plus-CAN	PPC-06-plus	PPC-08-plus	PPC-Pad

Rechargeable Battery	●	●	●	●	●
Number of Sensor Inputs	2 (max. 2 analogue sensors)	1x CAN (max. 3 CAN sensors)	3	4	max. 6 + 2 x CAN (each 8 sensors)
PC Interface	USB	USB	USB	USB	USB / Ethernet
Online Function	●	●	●	●	●
Internal Memory	●	●	●	●	●
Programming of Automatic Measuring Tasks	–	–	●	●	●
Internal Trigger Function	–	–	●	●	●
Data Display	●	●	●	●	●
Display Lightning	●	●	●	●	●
Curve Printout on Display	–	–	–	–	●
PC Software Kit	●	●	●	●	●
Pressure Measurement	●	●	●	●	●
Temperature Measurement	●	●	●	●	●
Flow Measurement	●	●	●	●	●
Rotational Speed Measurement	●	–	●	●	●
Frequency Measurement	●	●	●	●	●
Third-Party Sensors	●	●	●	●	●
Current / Voltage Adaptor	●	●	●	●	●
STAUFF CAN Sensor	–	●	–	–	●

● = standard, – = not available



Hydraulic Testers of the PPC Series

B



- ① Hydraulic Tester **PPC-04-plus**
max. two analogue sensors can be connected at the same time
- ② Hydraulic Tester **PPC-06-plus**
max. three analogue sensors can be connected at the same time
- ③ Hydraulic Tester **PPC-08-plus**
max. four analogue sensors can be connected at the same time
- ④ Hydraulic Tester **PPC-Pad**
max. six analogue sensors can be connected at the same time

- ⑤ Pressure Sensor **PPC-04/12-P**
- ⑥ Pressure / Temperature Sensor **PPC-04/12-PT**
- ⑦ Rotational Speed Sensor **PPC-04/12-SDS-CAB** with integrated connection cable, optionally with Contact Adaptor **PPC-04/12-SKA-Contact** or Focusing Adaptor **PPC-04/12-SKA-Focus**
- ⑧ Screw-in Temperature Sensor **PPC-04/12-T** Manual Temperature Sensor **PPC-04/12-TSH**
- ⑨ Flow Turbine **PPC-04/12-SFM** with integrated signal converter, for connecting pressure and temperature sensor

- ⑩ 5-pin Connection Cable for sensors **PPC-04/12-CAB3** (3 m / 9.84 ft), optionally with Extension Cable **PPC-04/12-CAB5-EXT** (5 m / 16.40 ft)
- ⑪ PPC Connection Cable as a component of the PC Sets **PC-SET-06/08-plus-SW-CAB** (USB)
- ⑫ PPC Connection Cable as a component of the PC Sets **PC-SET-04-plus-SW-CAB** (USB)
- ⑬ PPC Connection Cable as a component of the PC Sets **LAN- or USB 2.0-Cable**

Hydraulic Testers PPC Series (CAN Version)



- ① Hydraulic Tester **PPC-04-plus-CAN** with CAN interface (1x)
- ② Hydraulic Tester **PPC-Pad** with two CAN interfaces
- ③ CAN Pressure Sensor **PPC-CAN-P**
- ④ CAN Temperature Sensor **PPC-CAN-T**

- ⑤ CAN Pressure / Temperature Sensor **PPC-CAN-PT**
- ⑥ CAN Flow Turbine **PPC-CAN-SFM** with integrated signal converter, for connecting pressure and temperature sensors
- ⑦ CAN Connection Cable **PPC-CAN-CABX**
- ⑧ CAN Y-Splitter Cable **PPC-CAN-CAB-Y**

- ⑨ CAN Terminating Resistor **PPC-CAN-R**
- ⑩ PPC Connection Cable as a component of the PC Sets **PC-SET-04-plus-SW-CAB** (USB)
- ⑪ PPC Connection Cable as a component of the PC Sets **LAN- or USB 2.0-Cable**



Hydraulic Testers ■ Type PPC-04-plus / PPC-04-plus-CAN

B



PPC-04-plus with 2 sensor inputs for max. 2 analogue sensors



PPC-04-plus-CAN with CAN interface for max. 3 sensors (max. 50 m / 164 ft cable length)

Product Description

The PPC-04-plus and PPC-04-plus-CAN Hydraulic Testers have been developed for the growing demands in mobile and industrial hydraulic systems. They are perfectly suited for the precise determination of pressure, temperature, volume flow and rotational speed.

- Multi-line, backlit LCD display
- Max. two analogue sensors can be connected at the same time
- With CAN interface, max. three digital sensors can be connected at the same time
- Integrated data memory for 15000 data records
- External storage by using a USB memory stick (1 GB included)
- Max. CAN bus length: 50 m / 164 ft (CAN version)

The Hydraulic Testers are available in two versions. The PPC-04-plus, analogue version, comes with two inputs for connecting up to two analogue sensors at the same time. The PPC-04-plus-CAN comes with an CAN interface for connecting up to three digital sensors at the same time. Both versions provide automatic sensor recognition, thus making the tedious and often time-consuming parameterization of sensors redundant. The units can be easily operated via the keyboard and the individual device configurations can be viewed and managed.

Due to its extremely robust construction and oil-resistant rubber coating, the Hydraulic Testers can withstand impacts, vibrations, dust and moisture (protection class up to IP 67) and is designed for use in particularly harsh conditions.

The internal battery (Lithium Ion pack) can be charged via an micro USB connection, this connection can be also used to transfer the internally stored datas to a PC or notebook. Furthermore, this connection is also provided for real-time presentation of the measured values on the PC.

The PPC-04-plus devices can store up to 15000 data records and 270000 measured values. The included PPC software is compatible with popular PC operating systems (Windows XP®, Windows Vista®, Windows 7®, Windows 8® and Windows 10®) and permits various evaluation methods.

It is also possible to connect the Pressure Sensors under load, with the equipment switched on. The temperature and volume flow sensors are to be installed in the pipelines. The Rotational Speed Sensor is a non-contacting sensor and uses an optical mark on the rotating parts. Measuring the differential pressure requires two Pressure Sensors with identical measuring ranges.

The units are also available as a complete set. See pages 46 / 47 for further information.

Order Codes

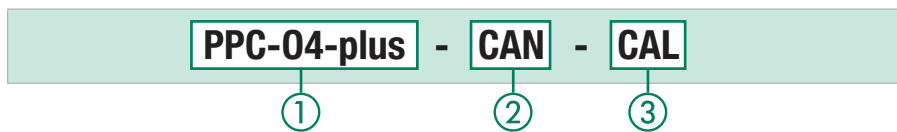

① Series and Type

Hydraulic Tester **PPC-04-plus**

② Version

Analogue version **(none)**
CAN version **CAN**

③ Calibration

Without calibration certificate **(none)**
With calibration certificate **CAL**

Note:
Calibration certificate is only available for the analogue Hydraulic Tester PPC-04-plus.

Technical Data

Materials

- Housing made of ABS in a rubber protective

Dimensions and Weight

- W x H x D: 96 x 172 x 54 mm / 3.78 x 6.77 x 2.13 in
- Weight: ca. 540 g / 1.19 lbs

Measurements / Display

- Pressure: in bar, PSI, mbar, kPa, MPa
- Temperature: in °C und °F
- Volume flow: in l/min and US GPM
- Rotational speed: in 1/min and RPM
- Display: FSTN-LCD, graphic, LED backlit
- Visible area: 62 x 62 mm / 2.44 x 2.44 in
- Resolution: 130 x 130 Pixel

Power Supply

- External: Micro USB socket, type B +5V DC, max. 1000 mA
- Battery: Lithium Ion pack
3,7 V DC / 2250 mAh or
3,7 V DC / 4500 mAh CAN version
- Operating time with the rechargeable battery: approx. 8 hours

Sensor Inputs

- Push-in connection: 5-pol., push-pull or 5-pol., M12x1, SPEEDCON, connector (CAN version)
- Automatic sensor recognition
- Sampling rate: 1 ms
- Accuracy: $\pm 0,2\% FS^* \pm 1 \text{ Digit}$

Permissible Temperatures

- Ambient: 0°C ... +50 °C / +32 °F ... +122 °F
- Storage: -25 °C ... +60 °C / -13 °F ... +140 °F

- Relative humidity: < 80 %
- CE certified

Interfaces

- USB device: Online transmission between unit and PC via PPC-Soft-plus (software)
Measured value transmission: ACT/MIN/MAX, min. 5 ms
USB standard: 2.0, fullspeed
Push-in connection: Micro USB socket, shielded, type A
Connection for USB stick, max. 4 GB
USB standard: 2.0, fullspeed, max. 100 mA
Push-on connection: Micro USB socket, shielded, type B
- USB host:

Protection Rating

- IP 54 protection rating: Dust protected and protected against splashing water
- (CAN version)
IP 67 protection rating: Dust tight and protected against splashing water

Software

A PC set, consisting of a USB connection lead, length 1 m / 3.28 ft and the corresponding PC software, is included in the scope of delivery. The measured data and curves can be easily transferred and processed by using PPC-Soft-plus software as well as exported to Microsoft Excel®.

SPEEDCON is a trademark of PHOENIX CONTACT GmbH & Co. KG
Dimensional drawings: All dimensions in mm (in).



Hydraulic Testers ■ Type PPC-06-plus / PPC-08-plus



PPC-08-plus with 4 sensor inputs



B

Order Codes

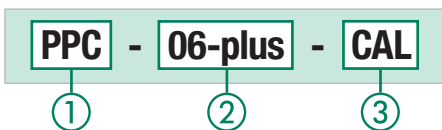

① Series and Type

 Hydraulic Tester **PPC**

② Version

 With 3 sensor inputs **06-plus**
 With 4 sensor inputs **08-plus**

③ Calibration

 Without calibration certificate **(none)**
 With calibration certificate **CAL**

Version	No. Sensor Inputs	Integrated Data Memory for Measured Value Points	Memory Curves
06-plus	3	1000000 Points	240000 Points
08-plus	4	1000000 Points	240000 Points

Software

A PC set, consisting of a USB connection lead, length 1,5 m / 4.9 ft and the corresponding PC software, is included in the scope of delivery.

The measured data and curves can be easily transferred and processed by using PPC-Soft-plus software as well as exported to Microsoft Excel®.

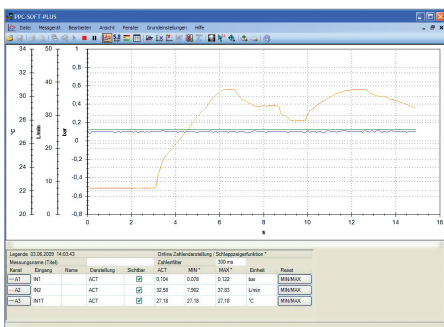

* FS = Full Scale

Technical Data

Material

- Housing made of fibreglass-reinforced PA

Dimensions and Weight

- W x H x D: 106 x 235 x 53 mm / 4.17 x 9.25 x 2.09 in
- Weight: 530 g / 1.17 lbs

Measurements / Display

- Pressure: in bar, PSI, mbar, kPa, MPa
- Temperature: in °C and °F
- Volumen flow: in l/min and US GPM
- Rotational speed: in 1/min and RPM
- Digital LCD display: 128 x 64 Pixel
- Visible area: 72 x 40 mm / 2.84 x 1.58 in
- Automatic numeral height adjustment
Numeral height: 6 mm / .24 in with eight-line display
- Data output for connection to neotebook or PC
- 12-key membrane keyboard
- Electromagnetic compatibility (EMC):
Emitted interference: DIN EN 50081, Part 1
Interference immunity: DIN EN 50082, Part 2
- Auto power off (after 20 minutes)
- Battery charge display

Measured Data Memory

- Variable memory interval (1 ms ... 10 s) or variable memory time (2 s ... 100 h)
- Manual and automatic triggering

Power Supply

- Power supply: 110/230 V AC (50/60 Hz)
- Rechargeable battery charging unit
- Internal nickel metal hydride (NiMH) battery 7,2 V / 700 mAh
- Operating time with the rechargeable battery: approx. 8 hours

Sensor Inputs (5-Pin)

- Automatic sensor detection
- Input signal: 0 ... 3 V DC (R = 470 kΩ)
- Frequency range: 0,5 Hz ... 30 kHz
- Sampling rate: 1 ms
- Accuracy: $\pm 0,25\% \text{ FS}$

Data Output

- Integrated USB port (USB 2.0)
- Online data transmission to a PC
Speed individually eligible (5 ms ... 60 s)

Permissible Temperature

- Ambient: 0 °C ... +50 °C / +32 °F ... +122 °F
- Storage: -25 °C ... +60 °C / -13 °F ... +140 °F
- Temperature error: <math>< 0,02\% \text{ / } ^\circ\text{C}</math>
- Relative humidity: <math>< 80\%</math>
- CE certified
- IP 54 protection rating: Dust protected and protected against splashing water

Product Description

The PPC-06/08-plus Hydraulic Testers have been especially developed for the growing demands of system monitoring and troubleshooting in hydraulic and pneumatic systems.

- Automatic sensor recognition
- Larger data memory
- Possible to record MIN-/MAX values over long periods
- Internal trigger function
- External trigger function
- Online data transmission
- Display lighting
- Programming by PC and notebook
- Integrated USB interface

The ergonomically designed housing and the LCD display, which sets automatically to the appropriate line size, now allows problem free use even under difficult environmental conditions.

The individual PPC-06-plus and PPC-08-plus Hydraulic Testers differ in the number of sensor inputs (3-channel or 4-channel technology).

Both Hydraulic Testers can measure, store and process all relevant hydraulic parameters such as pressure, differential pressure, temperature, rotational speed and flow.

The comprehensive programmer options, and the internal memory capacity in particular, allow for diverse measurements, trigger functions or measuring data from third-party sensors.

The PPC-06/08-plus devices can store up to 1000000 measuring value points and 240000 curve memory points. The stored values can be transferred using the built-in USB interface to a PC or notebook. The included PPC software is compatible with popular PC operating systems (Windows XP®, Windows Vista®, Windows 7®, Windows 8® and Windows 10®) and permits various evaluation methods.

The automatic sensor recognition feature makes the PPC-06-plus and the PPC-08-plus Hydraulic Testers easy to operate, and the testers can be individually configured to meet customer requirements without a great programming effort. Both Hydraulic Testers allow the data from third-party sensors to be measured and processed.

The units are also available as a complete set. See page 46 for further information.



Hydraulic Tester ■ Type PPC-Pad



B

Product Description

The application possibilities for hydraulics have recently increased throughout all areas of drive and control systems. This trend has been particularly noticeable in the sectors of machine, plant and automotive construction. At the same time, hydraulics and electronics have become increasingly intertwined.

STAUFF's hand-held measuring instrument PPC Pad helps you to deal with these new trends. It has never been so easy to follow the complex processes in these sectors with measurement, display and analysis. Potential uses include preventative maintenance, commissioning, troubleshooting and machine optimization.

The expanded requirements of these modern applications (such as the increased number of measurement points, longer cable lengths and high noise immunity) have driven further development of the CAN bus.

STAUFF's CAN bus sensors now take advantage of the bus system's automatic sensor recognition to provide an easy-to-install Plug & Play solution (max. CAN bus length 100 m / 328 ft). Compatibility with existing diagnostic sensors is also provided.

Our proven storage strategy is focused on MIN and MAX value measurements. Combined with a wide variety of value presentation styles, these features make effective solutions oriented analysis possible.

The PPC-Soft-plus PC software offers additional methods for analysis, control and remote maintenance using LAN and USB connections. Together with this software, the PPC Pad is a truly user-friendly measuring instrument that can be used for any type of diagnostics application.

Features

- Portable multi-function hand-held measuring instrument
- Pressure, temperature, flow and speed can be measured, monitored and analysed
- Measurement and display of over 50 channels
- Measured value display: numerical, bar graph, pointer, curve graph
- Project templates can be saved and loaded
- Interfaces: CAN, LAN, USB
- Total memory with up to 1 billion measured values
- Measured data can be (automatically) recorded, saved and analysed with the PPC-Soft-plus PC software and a LAN or USB connection
- Max. CAN bus length: 100 m / 328 ft

Scope of Delivery

- Hydraulic Tester PPC Pad
- Installed handle
- 24 V DC / 2,5 A Power Supply incl. country-specific Adaptor
- M8 x 1 / 4-pin (digital in/out)
- USB 2.0 cable (2 m / 6.56 ft)
- LAN cable (5 m / 16.40 ft)
- Operating instructions
- PC software
- MicroSD memory card
- M12 cable socket for 4 ... 20 mA / 0 ... 10 V aux. sensors

Technical Data

See page 31 for technical information.

Order Codes

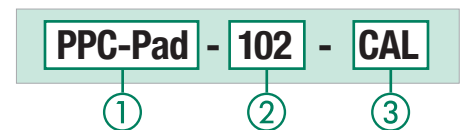

① Series and Type

Hydraulic Tester **PPC-Pad**

② Version

PPC-Pad-101	101
PPC-Pad-102	102
PPC-Pad-103	103

③ Calibration (only -102 / -103)

Without calibration certificate	(none)
With calibration certificate	CAL

Hydraulic Tester Version

Version	CAN Sensor Inputs	Sensor Inputs with Sensor Recognition STAUFF (Analogue)	Aux. Sensor Input (Analogue)
PPC-Pad-101	2 networks	-	-
PPC-Pad-102	each with 8 sensors max.	3	2
PPC-Pad-103		6	4



Hydraulic Tester ■ Type PPC-Pad



B

Technical Data (General)

Materials

- Housing: ABS/PC (Thermoplastic)
- Protective Sleeve: TPE (Thermoplastic Elastomer)

Dimensions and Weight

- W x H x D: 257 x 181 x 75 mm / 10.12 x 7.13 x 2.95 in
- Weight: 1550 g / 3.4 lbs (basic model)

Inputs / Outputs

- CAN sensor inputs: 2 CAN bus networks each with 8 sensors and max. 16 channels (for STAUFF CAN bus sensors)
Scanning rate: 1 ms = 1000 measured values/sec.
M12x1 push-in connector, 5-pin with SPEEDCON
- 1 digital trigger input: Scanning rate: 1 ms
Input impedance: 1 kΩ
Active high: >+7 ... +24 V DC
Active low: <1 V DC isolated
- 1 digital trigger output: Scanning rate: 1 ms
Max. switching signal: +24 V DC/max. 20 mA isolated
- Push-in connector for digital input and output: M8 x 1 / 4-pin, push-in connector

Module Slots

- 2, for input module, flexible placement possible
- Slot 1 = IN1, IN2, IN3, IN4/5
- Slot 2 = IN6, IN7, IN8, IN9/10 (expandable only by STAUFF)

Display

- FT-LCD colour graphic display
- Visible area: 115 x 86 mm/ 4.53 x 3.39 in
- Resolution: 640 x 480 Pixel

Interface

- USB device: Online data transmission between unit and PC via PPC-Soft-plus
Measured value transmission: ACT/MIN/MAX
USB standard: 2.0, fullspeed
Push-in connection: USB socket, shielded, type B

- USB host: Connection for mass storage devices such as USB memory stick or removable hard disc
standard: 2.0, fullspeed, 100 mA max.
Push-in connection: USB socket, shielded, type A
- Ethernet: Online data transmission between unit and PC via PPC-Soft-plus and remote control
Measured value transmission: ACT/MIN/MAX
standard: 10, 100 Mbit/s, IEEE 802.3 (10/100 base T)
Push-in connection: RJ45, socket, shielded

Functions

- Measurement: ACT/MIN/MAX avlues
- Measured value display: Numerical, bar graph, pointer, curve graph
- Measuring functions: Start/stop, points, trigger
- Trigger: Slope, manual, level, window, time, logic (interconnection of up to two events for the measurement start and stop)
- Pre-trigger
- Remote operation via the Ethernet
- Acoustic notification at any incident

Measured Data Memory

- For storing measured values, project data and screenshots
- Memory capacity: ≤4 million measured values per measurement
Total measured value memory >1 billion measured values
- Memory format: ACT/MIN/MAX
- Memory interval: 1 ms to 24 h
- Memory duration: 1 ms to 300 h (trigger measurement)
- Internal: 64 MB (approx. 32 million measured values)
- External SD memory: MicroSD memory card incl. in standard shipment
Slot: MicroSD memory card
- External USB mass memory device: up to 40 GB

Ambient Conditions

- Operating temperature: 0 °C ... +50 °C / +32 °F ... +122 °F
- Storage temperature: -25 °C ... +60 °C / -13 °F ... +140 °F
- Relative humidity: < 80 %
- Environmental test: IEC60068-2-32 (1 m, free fall)

Power Supply

- Internal: Lithium Ion pack, +7.4 V DC / 4500 mAh
Battery charging circuit/operating time with 3 CAN sensors: > 8 h

Protection Rating

- IP 64 protection rating: Dust tight and protected against splashing water

Technical Data (for PPC-Pad-102 and 103)

Input with Sensor Recognition

- 3 or 6 sensor inputs (up to 6 or 12 analogue measurement channels) with sensor recognition (p/T/Q/n) for PPC sensors
- Push-in connection: 5-pin, push-pull, combination panel plug/socket
- Scanning rate: 1 ms = 1000 measured values/sec.
- For the PPC-04/12-PT combined Pressure/Temperature Sensor, there is an additional temperature channel for each sensor input
- Temperature scanning: 1 s

Inputs for Auxiliary Sensors

- 2 analogue sensor inputs: for measuring current and voltage
Scanning rate: 1 ms = 1000 measured values/sec.
Voltage measuring range: -10 ... +10 V DC (freely configurable)
Current measuring range: 0/4 ... 20 mA
Supply external sensors: +18 ... +24 V DC/max. 100 mA
Push-in connection: M12x1, 5-pin socket
- FAST mode: Scanning rate: 0.1 ms = 10000 measured values/sec. only one auxiliary sensor input is useable

Accuracy

- +0,02 % per °C



Hydraulic Tester ■ Type PPC-Pad

B



Functional Description

- ① High protection from moisture and dirt due to cover caps and a rubber protective sleeve, protection class IP 64
- ② Illuminated display for good readability in any situation
- ③ Protection of the housing, affording usage in tough environments and absorption of shocks
- ④ Big 5.7 in colour display for clearly viewing the extensive information
- ⑤ Intuitive operation due to clear-cut control elements and function-oriented keys
- ⑥ Ergonomic housing shape ensures convenient portability and long operating times
- ⑦ Large keyboard and fonts for easy operation and readability
- ⑧ Portable multi-function hand-held measuring instrument - strong in design and tough in operation
- ⑨ Easy to carry and hang up with carrying strip
- ⑩ 110 / 240 V AC power supply, battery life 8 hours, recharging time 3 hours
- ⑪ 2 x CAN bus networks with each 16 channels
- ⑫ Modular design for up to 6 analogue sensors or 2 highspeed channels (0,1 ms) automatic sensor recognition
- ⑬ PC interface (USB 2.0); ACT/MIN/MAX measured value transmission to the PPC-Soft-plus software, terminal for USB mass storage devices
- ⑭ LAN interface for remote monitoring, MicroSD memory card for storage enlargement

Connection of Analogue Sensors / CAN Sensors

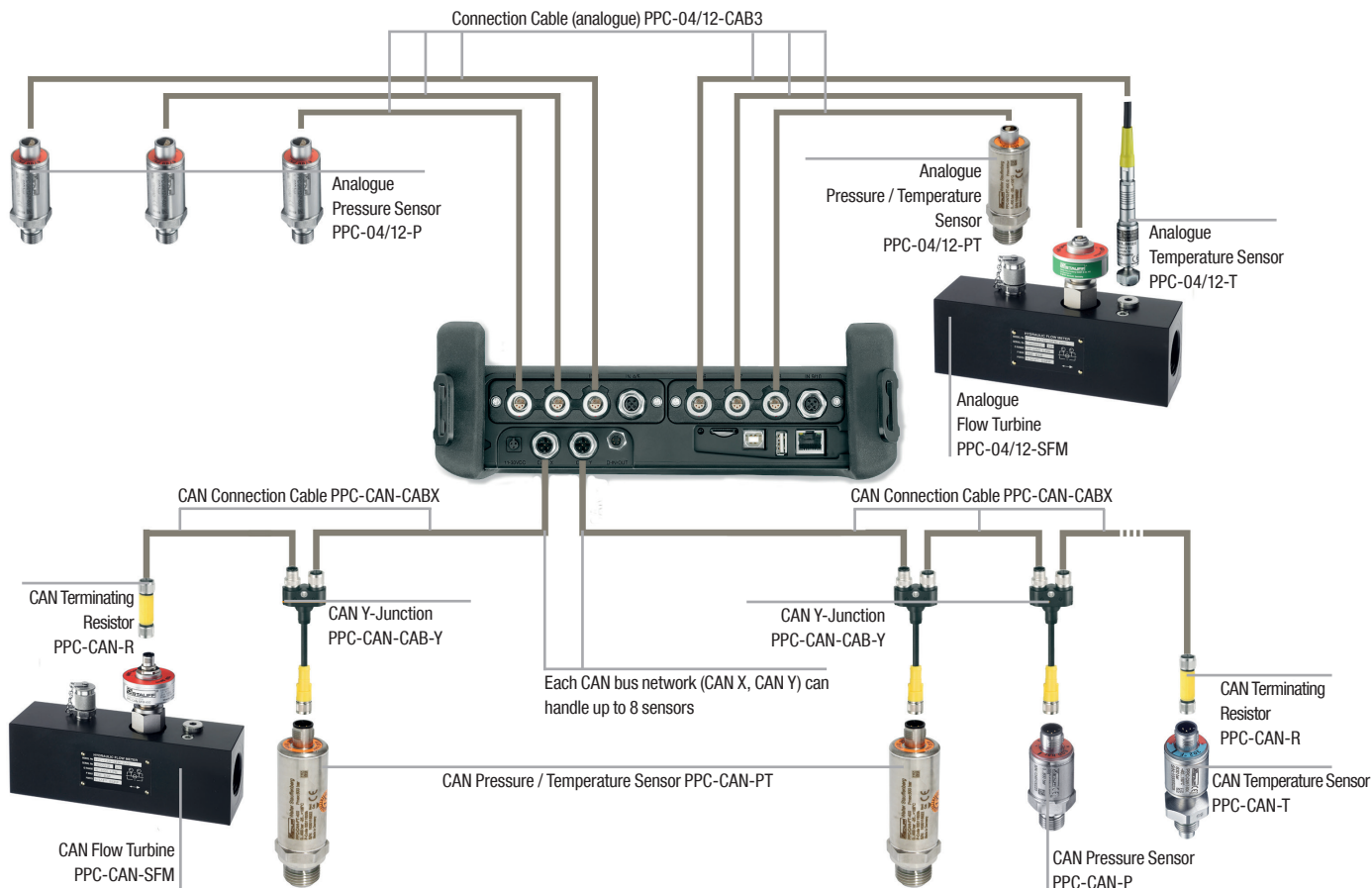

Hydraulic Tester ■ PPC-Pad-Display

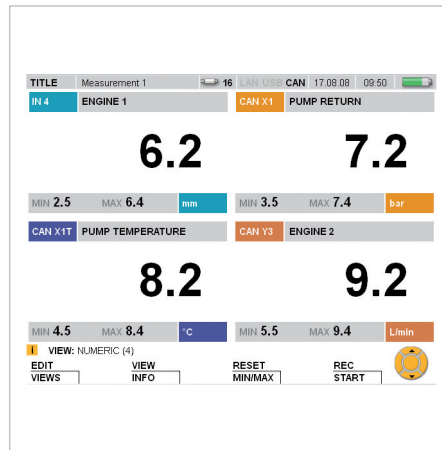
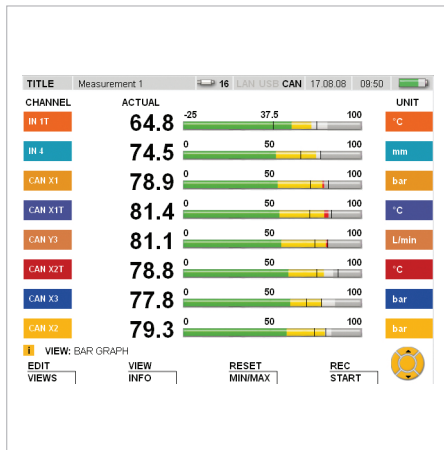

B

- Display of measured values as figures and bars
- Fixing of alarm ranges in green, yellow and red
- Trailing pointer function with MIN and MAX values

- Up to 4 channels in one large-format display
- Simultaneous display of ACT, MIN and MAX values
- Information lines of current settings, events and views
- Individual measurement channel identifier

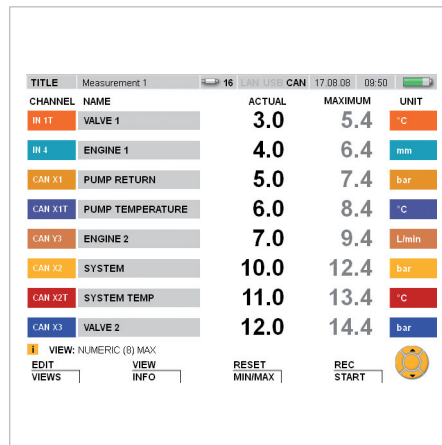
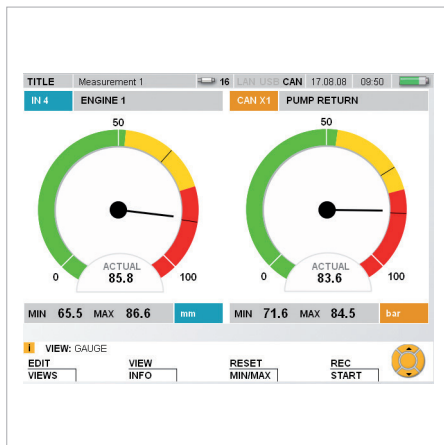

- Large-area pointer display of measured values
- Trailing pointer for MIN and MAX values
- Alarm range in green, yellow and red
- Further channels can be called up with the arrow keys

- Up to 8 channels in one display
- Colour allocation of the individual channels
- Uniform headings with measurement titles, sensors connected, interfaces, date, time and battery condition indicator
- Display can be changed between MIN and MAX values and full scale

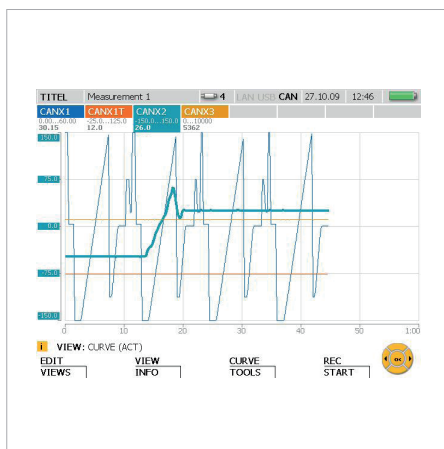

- Up to 8 channels in one graph display
- Fine, precise graph image thanks to high definition display
- Choice between ACT and MIN/MAX value display
- Automatic and manual scaling of the time axis for optimum measured value display



Pressure Sensor ■ Type PPC-04/12-P

B

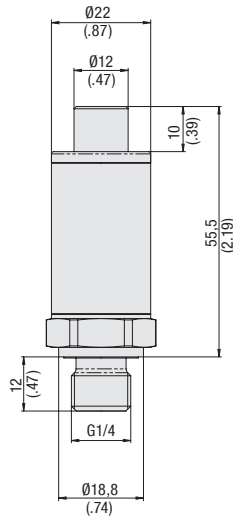

SDA-20-G1/4-W3

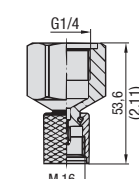

SAD-20/15-B-W3

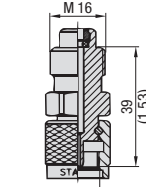
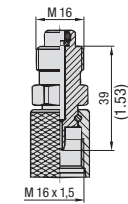

SAD-20/12-B-W3

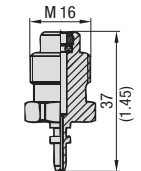

SAD-20/10-B-W3

Product Description

The Pressure Sensors PPC-04/12-P can be used with all analogue Hydraulic Testers of the PPC series, due to their 5-pin connection.

Due their sturdy Stainless Steel design, the quick response times (< 1 ms) and the high accuracy ($\pm 0,25\%$ FS* typ.) with automatic sensor recognition, the Pressure Sensors are a reliable and flexible solution for the Hydraulic Testers of the PPC series.

Note: A Connection Cable PPC-04/12-CAB3 (3 m / 9.84 ft) is needed to connect the Pressure Sensor PPC-04/12-P to the current Hydraulic Testers. An Extension Cable PPC-04/12-CAB5-EXT (5 m / 16.40 ft) is also available as an option. See page 44 for further information.

PPC-04/12-P	
Pressure Measurement	yes
Temperature Measurement	no
Process Connection	G1/4
Type	analogue 5-pin connection

Technical Data

- Sturdy Stainless Steel housing (1.4301)
- FKM (Viton®) gasket
- Weight: 85 g / .19 lbs
- Suitable for gases and liquids (in the case of aggressive media, only after contactation)
- 5-pin connection
- Pressure connection G1/4 (without adaptor)

Ambient Conditions

- Media temperature: -25 °C ... +105 °C / -13 °F ... +221 °F
- Ambient temperature: -25 °C ... +85 °C / -13 °F ... +185 °F
- Storage temperature: -25 °C ... +85 °C / -13 °F ... +185 °F
- Load cycles (10⁶): 100

Electrical Data

- Input voltage: 9 ... 36 V DC
- Output signal: 0 ... 3 V DC
- Response time: 1 ms
- Long-term stability: < 0,2 % FS* /a
- Vibration loading: acc. to IEC 60068-2-6 (20 g)
- Shock loading: acc. to IEC 60068-2-27 (50 g)

Order Codes

PPC-04/12-P - 015 - CAL

①

②

③

① Series and Type

Pressure Sensor **PPC-04/12-P**

② Version

See table

③ Calibration

Without calibration certificate **(none)**
 With calibration certificate **CAL**

Pressure Range and Accuracies

Version	Pressure Range and Accuracies					
Sensor	Pressure Measuring Range	Type of Measurement	Maximum Pressure	Burst Pressure	Accuracy	Accuracy
PPC-04/12-P-	(bar/PSI)		(bar/PSI)	(bar/PSI)	(±% FS*) typ.	(±% FS*) max.
015	-1 ... 15	Relative pressure	30	150	0,25	0,5
	-14,5 ... 217		435	2175		
060	0 ... 60	Absolute pressure	120	500	0,25	0,5
	0 ... 870		1740	7251		
150	0 ... 150	Absolute pressure	300	900	0,25	0,5
	0 ... 2175		4351	13053		
400	0 ... 400	Absolute pressure	800	1200	0,25	0,5
	0 ... 5801		11603	17404		
600	0 ... 600	Absolute pressure	1200	1800	0,25	0,5
	0 ... 8702		17404	26106		
601	0 ... 600 **	Absolute pressure	1200	2500	0,25	0,5
	0 ... 8702		17404	36259		

* FS = Full Scale

** Pressure peaks up to 1000 bar / 14503 PSI

Connection Adaptors for PPC Sensors

In addition to the Pressure Sensors, different adaptors and adaptor sets are available that not only connect to the STAUFF Test 20 (SDA-20-G1/4-W3), but also to the Test Couplings

of the STAUFF Test 15/12/10 series (SAD-20/15-B-W3, SAD-20/12-B-W3, SAD-20/10-B-W3). For further information please see Catalogue 7 - STAUFF Test.

Dimensional drawings: All dimensions in mm (in).



CAN Pressure Sensor ■ Type PPC-CAN-P

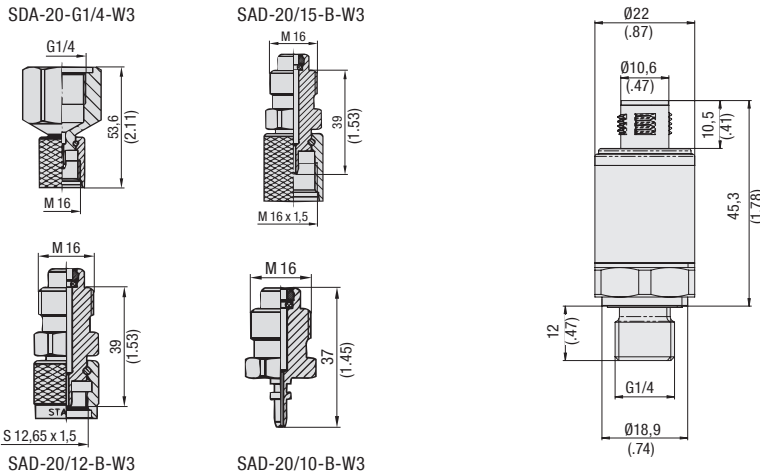

B

Order Codes

PPC-CAN-P - 016 - CAL

① ② ③

- ① **Series and Type**
CAN Pressure Sensor **PPC-CAN-P**
- ② **Version**
See table

- ③ **Calibration**
Without calibration certificate **(none)**
With calibration certificate **CAL**

Pressure Range and Accuracies

Version	Pressure Range and Accuracies					
Sensor	Pressure Measuring Range (bar/PSI)	Type of Measurement	Maximum Pressure (bar/PSI)	Burst Pressure (bar/PSI)	Accuracy (±% FS*) typ.	Accuracy (±% FS*) max.
016	-1 ... 16	Relative pressure	32	150	0,25	0,5
	-14,5 ... 232		464	2175		
060	0 ... 60	Absolute pressure	120	500	0,25	0,5
	0 ... 870		1740	7251		
160	0 ... 160	Absolute pressure	320	900	0,25	0,5
	0 ... 2320		4641	13053		
400	0 ... 400	Absolute pressure	800	1200	0,25	0,5
	0 ... 5801		11603	17404		
600	0 ... 600	Absolute pressure	1200	1800	0,25	0,5
	0 ... 8702		17404	26106		
601	0 ... 600**	Absolute pressure	1200	2500	0,25	0,5
	0 ... 8702		17404	36259		

* FS = Full Scale

**Pressure peaks up to 1000 bar / 14503 PSI

Connection Adaptors for PPC Sensors

In addition to the CAN Pressure Sensors, different adaptors and adaptor sets are available that not only connect to the STAUFF Test 20 (SDA-20-G1/4-W3), but also to the Test

Couplings of the STAUFF Test 15/12/10 series (SAD-20/15-B-W3, SAD-20/12-B-W3, SAD-20/10-B-W3). For further information please see Catalogue 7 - STAUFF Test.

Product Description

The CAN Pressure Sensors PPC-CAN-P are specially designed for use with the CAN Hydraulic Testers. These sensors are using the CANopen protocol to transfer the measurement values to the CAN Hydraulic Testers. Most technical details are the same as with the Pressure Sensors. Due their sturdy Stainless Steel design, the quick response times (< 1 ms) and the high accuracy (±0,25% FS* typ.) with automatic sensor recognition, the CAN Pressure Sensors are a reliable and flexible solution for the CAN Hydraulic Tester. The status of the sensor is indicated via LED.

Connecting the CAN Pressure Sensor to the CAN Hydraulic Tester a CAN Connection Cable and a CAN Terminating Resistor is needed. See page 45 for further information.

PPC-CAN-P	
Pressure Measurement	yes
Temperature Measurement	no
Process Connection	G1/4
Type	CAN connection 5-pin, M12x1

Technical Data

- Sturdy Stainless Steel housing (1.4301)
- FKM (Viton®) gasket
- Sensor identification LED
- Weight: 85 g / .19 lbs
- Suitable for gases and liquids (in the case of aggressive media, only after contactation)
- 5-pin SPEEDCON connection plug
- Pressure connection G1/4 (without adaptor)

Ambient Conditions

- Media temperature: -25 °C ... +105 °C / -13 °F ... +221 °F
- Ambient temperature: -25 °C ... +85 °C / -13 °F ... +185 °F
- Storage temperature: -25 °C ... +85 °C / -13 °F ... +185 °F
- Load cycles (10⁶): 100

CANopen Interface

- CANopen protocol profile DS406 v3.2 with manufacturer-specific additions
- LSS service DS305 v2.0

Electrical Data

- Response time: 1 ms
- Long-term stability: < 0,2 % FS* /a
- Vibration loading: acc. to IEC 60068-2-6 (20 g)
- Shock loading: acc. to IEC 60068-2-27 (50 g)



Temperature Sensor - Type PPC-04/12-T

B

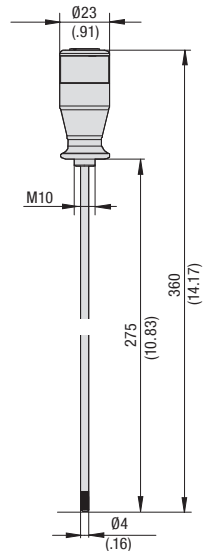
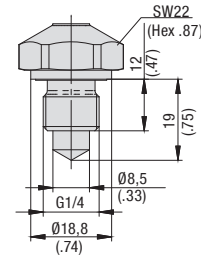
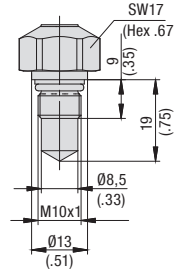
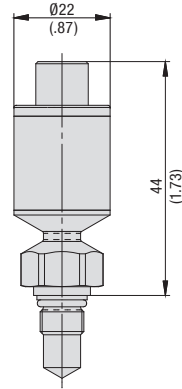

Screw-in Temperature Sensor (T) Process Connection M10x1 Process Connection G1/4 Rod-type Temperature Sensor (TSH)

Product Description

The Screw-in Temperature Sensors PPC-04/12-T measure current temperature directly in the pipeline and are compatible with the Flow Turbine PPC-04/12-SFM and the Straight Threaded Joint SGV-16S-G-W3 (only process connection M10x1, see figure below). See product information of Flow Turbine on page 40.

The Rod-type Temperature Sensor PPC-04/12-TSH is especially designed to determine the media temperatures in tanks and containers.

Note: A Connection Cable PPC-04/12-CAB3 (3 m / 9.84 ft) is needed to connect the Temperature Sensor PPC-04/12-T or -TSH to the current Hydraulic Testers. An Extension Cable PPC-04/12-CAB5-EXT (5 m / 16.40 ft) is also available as an option. See page 44 for further information.

PPC-04/12-T	
Pressure Measurement	no
Temperature Measurement	yes
Process Connection	M10x1 or G1/4
Type	analogue 5-pin connection

PPC-04/12-T-M02 with SGV-16S-G-W3

For further information please see Catalogue 7 - STAUFF Test.



Order Codes

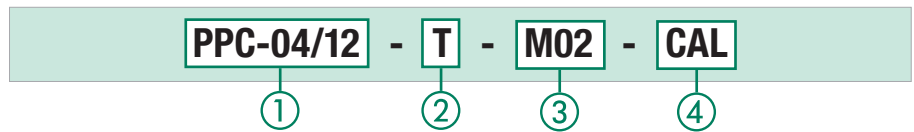

1 Series and Type

Temperature Sensor PPC-04/12

2 Version

Screw-in T
Rod-type TSH

3 Process Connection (only for Version T)

M10x1 M02
G1/4 B04

4 Calibration

Without calibration certificate (none)
With calibration certificate CAL

Technical Data

- Suitable for liquids (in the case of aggressive media only after contactation)
- 5-pin connection

Materials

- Housing (T): Stainless Steel
- Gaskets (T): FKM (Viton®)
- Rod (TSH): Stainless Steel 1.4304
- Handle (TSH): Delrin

Weight

- Screw-in (T)
 - M02 (M10x1): 70 g / .15 lbs
 - B04 (G1/4): 55 g / .12 lbs
- Rod-type (TSH): 120 g / .26 lbs

Connection

- STAUFF Test connection SGV-16S-G-W3 in the pipeline (only M10x1)
- Screw-in thread (T): M10x1 or G1/4 (see figure)
- Screw-in thread (TSH): M10

Ambient Conditions (Screw-in Temperature Sensor)

- Media temperature: -40°C ... +150°C / -40°F ... +302°F
- Ambient temperature: -40°C ... +85°C / -40°F ... +185°F
- Storage temperature: -40°C ... +85°C / -40°F ... +185°F

Ambient Conditions (Rod-type Temperature Sensor)

- Media temperature: -25°C ... +125°C / -13°F ... +257°F
- Ambient temperature: -25°C ... +70°C / -13°F ... +158°F
- Storage temperature: -25°C ... +80°C / -13°F ... +176°F

Measuring Range

- Measuring range (T): -40°C ... +150°C / -40°F ... +302°F
- Measuring range (TSH): -25°C ... +125°C / -13°F ... +257°F
- Operating pressure (T): 630 bar / 9137 PSI
- Maximum pressure (T): 800 bar / 11603 PSI
- Burst pressure (T): 2150 bar / 31183 PSI
- Accuracy: ±1 % FS

Electrical Data

- Input signal: 7 ...12 V DC
- Output signal: 0 ...3 V DC
- Response time (T)
 - M02 (M10x1): T₉₀ ≤ 4 s, T₉₅ ≤ 14 s
 - B04 (G1/4): T₉₀ ≤ 4 s, T₉₅ ≤ 12 s
- Response time (TSH): T₉₀ ≤ 9,1 s
- Vibration loading: acc. to IEC 60068-2-6 (20 g)
- Shock loading: acc. to IEC 60068-2-27 (50 g)

* FS = Full Scale

Dimensional drawings: All dimensions in mm (in).



CAN Temperature Sensor ■ Type PPC-CAN-T

B

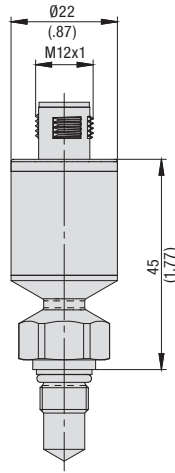
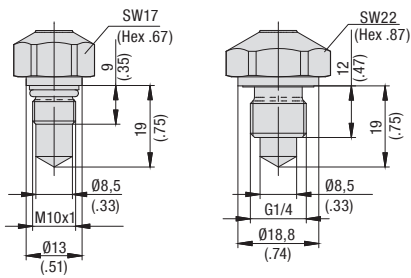

Process Connection M10x1

Process Connection G1/4



Order Codes

PPC-CAN - T - M02 - CAL

①

②

③

④

① Series and Type

 CAN Temperature Sensor **PPC-CAN**

② Version

 Screw-in **T**

③ Process Connection (only for Version T)

 M10x1 **M02**
 G1/4 **B04**

④ Calibration

 Without calibration certificate **(none)**
 With calibration certificate **CAL**

Technical Data

- Suitable for liquids (in the case of aggressive media only after contactation)
- 5-pin SPEEDCON connection plug
- Sensor identification LED

Materials

- Housing: Stainless Steel
- Gaskets: FKM (Viton®)

Weight

- M02 (M10x1): 70 g / .15 lbs
- B04 (G1/4): 55 g / .12 lbs

Ambient Conditions

- Media temperature: -40 °C ... +150 °C / -40 °F ... +302 °F
- Ambient temperature: -40 °C ... +85 °C / -40 °F ... +185 °F
- Storage temperature: -40 °C ... +85 °C / -40 °F ... +185 °F

Measuring Range

- Measuring range: -40 °C ... +150 °C / -40 °F ... +302 °F
- Operating pressure: 630 bar / 9137 PSI
- Maximum pressure: 800 bar / 11603 PSI
- Burst pressure: 2150 bar / 31183 PSI
- Accuracy: ±0,66 % FS

CANopen Interface

- CANopen protocol profile DS301, Typ 2.0A with manufacturer-specific additions
- LSS service DS305 v2.0

Electrical Data

- Output signal: CAN bus
- Response time:
 - M02 (M10x1): $T_{90} \leq 4 \text{ s}$, $T_{95} \leq 12 \text{ s}$
 - B04 (G1/4): $T_{90} \leq 4 \text{ s}$, $T_{95} \leq 14 \text{ s}$
- Vibration loading: acc. to IEC 60068-2-6 (20 g)
- Shock loading: acc. to IEC 60068-2-27 (50 g)

Product Description

The CAN Temperature Sensor PPC-CAN-T are specially designed for use with the CAN Hydraulic Testers. This sensor is using the CANopen protocol to transfer the measurement values to the CAN Hydraulic Testers. The PPC-CAN-T is compatible with the CAN Flow Turbine PPC-CAN-SFM and the Straight Threaded Joint SGV-16S-G-W3 (only process connection M10x1, see figure below). See product information of CAN Flow Turbine on page 41.

Most technical details are the same as with the Temperature Sensor PPC-04/12-T.

Due their sturdy Stainless Steel design with automatic sensor recognition, the CAN Temperature Sensor is a reliable and flexible solution for the CAN Hydraulic Tester. The status of the sensor is indicated via LED.

Connecting the CAN Temperature Sensor to the CAN Hydraulic Tester a CAN Connection Cable and a CAN Terminating Resistor is needed. See page 45 for further information.

PPC-CAN-T	
Pressure Measurement	no
Temperature Measurement	yes
Process Connection	M10x1 or G1/4
Type	CAN connection 5-Pin, M12x1

PPC-CAN-T-M02 with SGV-16S-G-W3

For further information please see Catalogue 7 - STAUFF Test.



* FS = Full Scale

SPEEDCON is a trademark of PHOENIX CONTACT GmbH & Co. KG

Dimensional drawings: All dimensions in mm (in).



Pressure / Temperature Sensor ■ Type PPC-04/12-PT

B

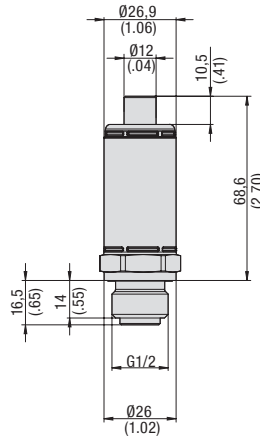

SDA-20-G1/2-W3

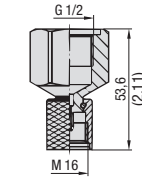

SAD-20/15-B-W3

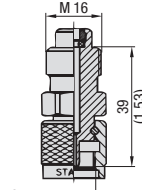
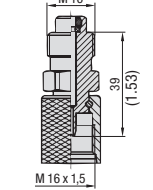

SAD-20/12-B-W3

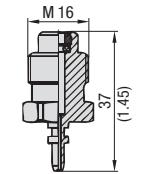

SAD-20/10-B-W3

Product Description

The Pressure / Temperature Sensor PPC-04/12-PT can be used with all Hydraulic Testers of the PPC series, due to the 5-pin connection. This sensor is able to measure and display temperatures on the Hydraulic Testers.

Due to the sturdy Stainless Steel design, the quick response time (< 1 ms) and the high accuracy ($\pm 0,25\%$ FS* typ.) with automatic sensor recognition, the Pressure / Temperature Sensor is a reliable and flexible solution for the Hydraulic Testers of the PPC series.

Note: A Connection Cable PPC-04/12-CAB3 (3 m / 9.84 ft) is needed to connect the Pressure / Temperature Sensor to the current Hydraulic Testers. An Extension Cable PPC-04/12-CAB5-EXT (5 m / 16.40 ft) is also available as an option. See page 44 for further information.

PPC-04/12-PT-	
Pressure Measurement	yes
Temperature Measurement	yes
Process Connection	G1/2
Type	analogue 5-pin connection

Technical Data

- Sturdy Stainless Steel housing (1.4301)
- FKM (Viton®) gasket
- Weight: 200 g / .44 lbs
- Suitable for gases and liquids (in the case of aggressive media, only after contactation)
- 5-Pin connection
- Pressure connection G1/2 (without adaptor)

Ambient Conditions

- Media temperature: -25 °C ... +105 °C / -13 °F ... +221 °F
- Ambient temperature: -25 °C ... +85 °C / -13 °F ... +185 °F
- Storage temperature: -25 °C ... +85 °C / -13 °F ... +185 °F
- Compensated range: 0 °C ... +85 °C / +32 °F ... +285 °F
- Load cycles (10⁶): 100

Electrical Data

- Input voltage: 7 ... 12 V DC
- Output signal: 0 ... 3 V DC
- Response time: 1 ms
- Long-term stability: < 0,2 % FS* / a
- Vibration loading: acc. to IEC 60068-2-6 (20g)
- Shock loading: acc. to IEC 60068-2-27 (50g)

Order Codes

PPC-04/12-PT - 015/2 - CAL

①

②

③

① Series and Type

Pressure / Temperature Sensor **PPC-04/12-PT**

② Version

See table

③ Calibration

Without calibration certificate **(none)**
With calibration certificate **CAL**

Pressure Range and Accuracies

Version	Pressure Range and Accuracies							
Sensor	Pressure Measuring Range (bar/PSI)	Type of Measurement	Maximum Pressure (bar/PSI)	Burst Pressure (bar/PSI)	Accuracy ($\pm\%$ FS*) typ.	Accuracy ($\pm\%$ FS*) max.	Temperature Measuring Range (°C/°F)	Accuracy ($\pm\%$ FS*)
015/2	-1 ... 15	Relative pressure	30	150	0,25	0,5	-25 ... 105	1,5
	-14,5 ... 217		435	2175				
060/2	0 ... 60	Absolute pressure	120	500	0,25	0,5	-25 ... 105	1,5
	0 ... 870		1740	7251				
150/2	0 ... 150	Absolute pressure	300	900	0,25	0,5	-25 ... 105	1,5
	0 ... 2175		4351	13053				
400/2	0 ... 400	Absolute pressure	800	1200	0,25	0,5	-25 ... 105	1,5
	0 ... 5801		11603	17404				
600/2	0 ... 600	Absolute pressure	1200	1800	0,25	0,5	-25 ... 105	1,5
	0 ... 8702		17404	26106				
601/2	0 ... 600 **	Absolute pressure	1200	2500	0,25	0,5	-25 ... 105	1,5
	0 ... 8702		17404	36259				

* FS = Full Scale

** Pressure peaks up to 1000 bar / 14503 PSI

Connection Adaptors for PPC Sensors

In addition to the Pressure / Temperature Sensors, different adaptors and adaptor sets are available that not only connect to the STAUFF Test 20 (SDA-20-G1/2-W3), but also to the Test Couplings of the STAUFF Test 15/12/10 series (SAD-20/15-B-W3, SAD-20/12-B-W3, SAD-20/10-B-W3). For further information please see Catalogue 7 - STAUFF Test.

Dimensional drawings: All dimensions in mm (in).



CAN Pressure / Temperature Sensor ■ Typ PPC-CAN-PT

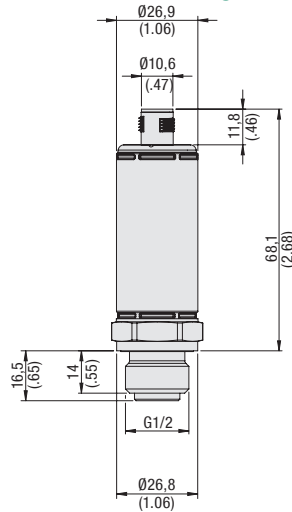
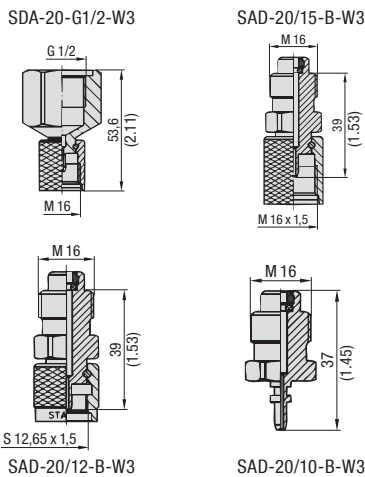

Order Codes

PPC-CAN-PT - 016 - CAL

① Series and Type

 CAN Pressure / Temperature Sensor **PPC-CAN-PT**

② Version

See table

③ Calibration

 Without calibration certificate **(none)**
 With calibration certificate **CAL**

Pressure Range and Accuracies

Version	Pressure Range and Accuracies							
Sensor PPC-CAN-PT-	Pressure Measuring Range (bar/psi)	Type of Measurement	Maximum Pressure (bar/psi)	Burst Pressure (bar/psi)	Accuracy (±% FS*) typ.	Accuracy (±% FS*) max.	Temperature Measuring Range (°C/°F)	Accuracy (±% FS*)
016	-1 ... 16	Relative pressure	32	150	0,25	0,5	-25 ... 105	±2K typ./ ±3K max.
	-14.5 ... 232		464	2175			-13 ... 221	±3K max.
060	0 ... 60	Absolute pressure	120	500	0,25	0,5	-25 ... 105	±2K typ./ ±3K max.
	0 ... 870		1740	7251			-13 ... 221	±3K max.
160	0 ... 160	Absolute pressure	320	900	0,25	0,5	-25 ... 105	±2K typ./ ±3K max.
	0 ... 2320		4641	13053			-13 ... 221	±3K max.
400	0 ... 400	Absolute pressure	800	1200	0,25	0,5	-25 ... 105	±2K typ./ ±3K max.
	0 ... 5801		11603	17404			-13 ... 221	±3K max.
600	0 ... 600	Absolute pressure	1200	1800	0,25	0,5	-25 ... 105	±2K typ./ ±3K max.
	0 ... 8702		17404	26106			-13 ... 221	±3K max.
601	0 ... 600 **	Absolute pressure	1200	2500	0,25	0,5	-25 ... 105	±2K typ./ ±3K max.
	0 ... 8702		17404	36259			-13 ... 221	±3K max.

* FS = Full Scale

** Pressure peaks up to 1000 bar / 14503 PSI

Connection Adaptors for PPC Sensors

In addition to the CAN Pressure / Temperature Sensors, different adaptors and adaptor sets are available that not only connect to the STAUFF Test 20 (SDA-20-G1/2-W3), but also to the Test Couplings of the STAUFF Test 15/12/10 series

(SAD-20/15-B-W3, SAD-20/12-B-W3, SAD-20/10-B-W3).
 For further information please see Catalogue 7 - STAUFF Test.

Product Description

The CAN Pressure / Temperature Sensors PPC-CAN-PT are specially designed for use with the CAN Hydraulic Testers. This sensor is using the CANopen protocol to transfer the measurement values to the CAN Hydraulic Testers. Most technical details are the same as with the Pressure / Temperature Sensor PPC-04/12-PT. The CAN sensor is able to measure and display temperatures on the CAN Hydraulic Testers.

Due to the sturdy Stainless Steel design, the quick response time (< 1 ms) and the high accuracy (±0,25% FS* typ.) with automatic sensor recognition, the pressure / temperature sensor is a reliable and flexible solution for the CAN Hydraulic Tester. The status of the sensor is indicated via LED.

Connecting the CAN Pressure / Temperature Sensor to the CAN Hydraulic Tester a CAN Connection Cable and a CAN Terminating Resistor is needed. See page 45 for further information.

PPC-CAN-PT	
Pressure Measurement	yes
Temperature Measurement	yes
Process Connection	G1/2
Type	CAN connection 5-pin, M12x1

Technical Data

- Sturdy Stainless Steel housing (1.4301)
- FKM (Viton®) gasket
- Sensor identification LED
- Weight: 200 g / .44 lbs
- Suitable for gases and liquids (in the case of aggressive media, only after contactation)
- 5-pin SPEEDCON connection plug
- Pressure connection G1/2 (without adaptor)

Ambient Conditions

- Media temperature: -25 °C ... +105 °C / -13 °F ... +221 °F
- Ambient temperature: -25 °C ... +85 °C / -13 °F ... +185 °F
- Storage temperature: -25 °C ... +85 °C / -13 °F ... +185 °F
- Compensated range: 0 °C ... +85 °C / +32 °F ... +185 °F
- Load cycles (10⁶): 100

CANopen Interfaces

- CANopen protocol profile DS406 v3.2 with manufacturer-specific additions
- LSS service DS305 v2.0

Electrical Data

- Response time: 1 ms
- Vibration loading: acc. to IEC 60068-2-6 (20g)
- Shock loading: acc. to IEC 60068-2-27 (50g)



Flow Turbine ■ Type PPC-04/12-SFM

B

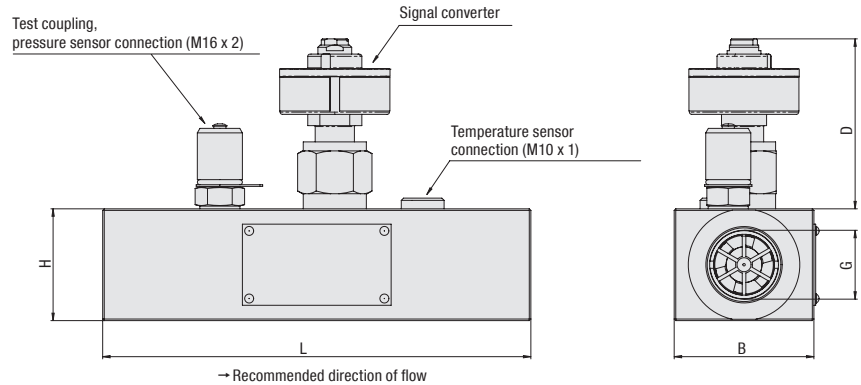

Product Description

The PPC-04/12-SFM Flow Turbine is permanently installed in the pipeline. The oil flow rotates the internal axial turbine. The frequencies generated are processed by digital electronics (a signal converter). Interferences caused by flow effects are compensated by this process. The signal converter is now directly integrated into the Flow Turbine. This allows even simpler operation and supports permanent coupling of the turbine and signal converter components that are matched to one another.

The Flow Turbine also improves the response time (from previously 400 ms to 50 ms) and increases the measuring accuracy.

The PPC-04/12-SFM is available in five versions for various flow speeds. A Pressure Sensor PPC-04/12-P (see page 34) can be connected in parallel to the Flow Turbine by way of the integrated test coupling. In addition, the oil temperature can also be measured using the connection of the Temperature Sensor PPC-04/12-T (see page 36).

In general, the Flow Turbine can handle flows in either direction. The specified technical data and the calibration (available as an option) apply only when the flow through the Flow Turbine matches the recommended flow direction. A double-headed arrow is shown on the nameplate of the PPC-04/12-SFM. The thicker end of the double-headed arrow specifies the recommended direction of flow.

Note: A Connection Cable PPC-04/12-CAB3 (3 m / 9.84 ft) is needed to connect the Flow Turbine to the current Hydraulic Testers.

An Extension Cable PPC-04/12-CAB5-EXT (5 m / 16.40 ft) is also available as an option. See page 44 for further information.

Technical Data

Materials

- Housing: Aluminium (black anodised)
- Gaskets: FKM (Viton®)
- 5-pin connection
- Pressure measurement connection: SMK-20 (M16 x 2)
- Temperature measurement connection: M10 x 1 (standard screw plug)

Ambient Conditions

- Media temperature: -20 °C ... +90 °C / -4 °F ... +194 °F
- Ambient temperature: -10 °C ... +50 °C / +14 °F ... +122 °F
- Storage temperature: -20 °C ... +80 °C / -4 °F ... +176 °F
- Permissible particle size: <10 Micron for SFM-015, <25 Micron for others
- Viscosity range: 10 ... 100 cSt

Electrical Data

- Response time: 50 ms

Process Connection

- Please see table below

Order Codes



① Series and Type

Flow Turbine **PPC-04/12**

② Version

1 ... 15 l/min / .27 ... 3.90 US GPM	SFM-015
3 ... 60 l/min / .79 ... 15.90 US GPM	SFM-060
5 ... 150 l/min / 1.32 ... 39.60 US GPM	SFM-150
8 ... 300 l/min / 2.11 ... 79.00 US GPM	SFM-300
15 ... 600 l/min / 3.96 ... 158.00 US GPM	SFM-600

③ Calibration

Without calibration certificate	(none)
With calibration certificate	CAL

UNF version available on request.

Dimensions and Measuring Range

Version	Measuring Range		Operating Pressure (bar/PSI)	Max. Pressure (bar/PSI)	Accuracy (at 21 cSt)	Max. Pressure Drop (at FS*) (bar/PSI)	Dimensions (mm/in)						Weight (kg/lbs)
	Flow Turbine PPC-04/12-	Measuring Range (l/min / US GPM)					Max. Flow (l/min / US GPM)	G ** (BSP)	G (UNF)	B	D	L	
SFM-015	1 ... 15	16.5	350	420	±1 (% FS*)	1.5	G1/2	3/4-16	37	71	136	37	650
	.27 ... 3.90	4.4	5076	6091									
SFM-060	3 ... 60	66	350	420	±1 (% of the displayed value)	1.5	G3/4	1-1/16-16	62	72	190	50	750
	.79 ... 15.90	17.4	5076	6091									
SFM-150	5 ... 150	165	350	420	±1 (% of the displayed value)	1.5	G3/4	1-1/16-16	62	72	190	50	750
	1.32 ... 39.60	43.6	5076	6091									
SFM-300	8 ... 300	330	350	420	±1 (% of the displayed value)	4	G1	1-5/16-16	62	76	190	50	1200
	2.11 ... 79.00	87.2	5076	6091									
SFM-600	15 ... 600	660	290	348	±1 (% of the displayed value)	5	G1-1/4	1-5/8-12	62	66	212	75	1800
	3.96 ... 158.00	174.4	4206	5047									

* FS = Full Scale

** Standard option

Dimensional drawings: All dimensions in mm (in).



CAN Flow Turbine ▪ Type PPC-CAN-SFM

B

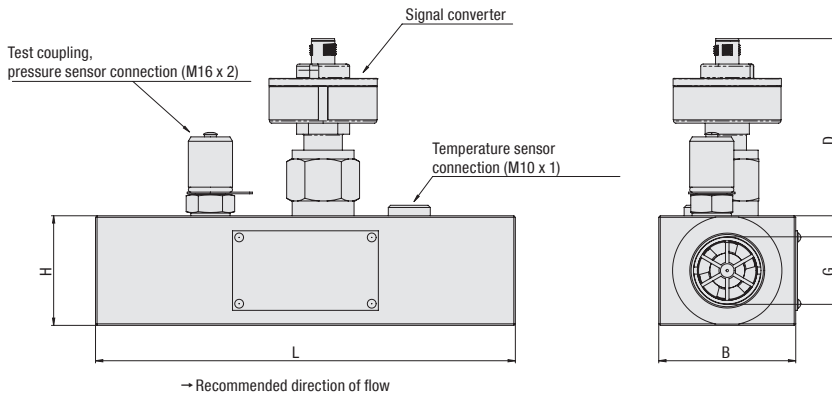

Order Codes

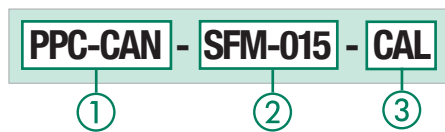

1 Series and Type

CAN Flow Turbine **PPC-CAN**

2 Version

1 ... 15 l/min / .27 ... 3.90 US GPM	SFM-015
3 ... 60 l/min / .79 ... 15.90 US GPM	SFM-060
5 ... 150 l/min / 1.32 ... 39.60 US GPM	SFM-150
8 ... 300 l/min / 2.11 ... 79.00 US GPM	SFM-300
15 ... 600 l/min / 3.96 ... 158.00 US GPM	SFM-600

3 Calibration

Without calibration certificate	(none)
With calibration certificate	CAL

UNF version available on request.

Technical Data

Materials

- Housing: Aluminium (black anodised)
- Gaskets: FKM (Viton®)
- 5-pin SPEEDCON connection plug
- Pressure measurement connection: SMK-20 (M16 x 2)
- Temperature measurement connection: M10 x 1 (standard screw plug)

Ambient Conditions

- Media temperature: -20 °C ... +90 °C / -4 °F ... +176 °F
- Ambient temperature: -10 °C ... +50 °C / +14 °F ... +122 °F
- Storage temperature: -20 °C ... +80 °C / -4 °F ... +176 °F
- Permissible particle size: <10 Micron for SFM-015 (CAN), <25 Micron for others
- Viscosity range: 10 ... 100 cSt

Electrical Data

- Response time: 50 ms

Process Connection

- Please see table below

Product Description

The CAN Flow Turbine PPC-CAN-SFM is specially designed for the use with the CAN Hydraulic Testers and has to be installed permanently in the pipeline where the oil flow rotates the internal axial turbine. The generated frequencies are processed by digital electronics (a signal converter). Interferences caused by flow effects are compensated by this process. The signal converter is now directly integrated into the CAN Flow Turbine. This allows even simpler operation and supports permanent coupling of the turbine and signal converter components that are matched to one another.

The CAN Flow Turbine also improves the response times/ reaction times (from a previous 400 ms to 50 ms) and increases measurement accuracy.

The CAN Flow Turbine is available in five versions for various flow speeds. A CAN Pressure Sensor PPC-CAN-P (see page 35) can be connected parallel to the CAN Flow Turbine by the way of the integrated test coupling. In addition, the oil temperature can also be measured using the connection of the Temperature Sensor PPC-CAN-T (see page 37).

In general, the CAN Flow Turbine can handle flows in either direction. The specified technical data and the calibration (available as an option) apply only when the flow through the CAN Flow Turbine matched the recommended flow direction. A double-headed arrow is shown on the nameplate of the PPC-CAN-SFM. The thicker end of the double-headed arrow specifies the recommended direction of the flow.

Connecting the CAN Flow Turbine to the CAN Hydraulic Tester a CAN Connection Cable and a CAN Terminating Resistor is needed. See page 45 for further information.

Dimensions and Measuring Range

Version	Measuring Range						Dimensions (mm/in)						
	Measuring Range (l/min/US GPM)	Max. Flow (l/min/US GPM)	Operating Pressure (bar/PSI)	Max. Pressure (bar/PSI)	Accuracy (at 21 cSt)	Max. Pressure Drop (at FS*) (bar/PSI)	G ** (BSP)	G (UNF)	B	D	L	H	Weight (kg/lbs)
SFM-015	1 ... 15	16,5	350	420	±1 (% FS*)	1,5	G1/2	3/4-16	37	78,8	136	37	650
	.26 ... 3.90	4.4	5076	6091		21.8							
SFM-060	3 ... 60	66	350	420	±1 (% of the displayed value)	1,5	G3/4	1-1/16-16	62	79,4	190	50	750
	.79 ... 15.90	17.4	5076	6091		21.8							
SFM-150	5 ... 150	165	350	420	±1 (% of the displayed value)	1,5	G3/4	1-1/16-16	62	79,4	190	50	750
	1.32 ... 39.60	43.6	5076	6091		21.8							
SFM-300	8 ... 300	330	350	420	±1 (% of the displayed value)	4	G1	1-5/16-16	62	81,3	190	50	1200
	2.11 ... 79.00	87.2	5076	6091		58							
SFM-600	15 ... 600	660	290	348	±1 (% of the displayed value)	5	G1-1/4	1-5/8-12	62	76,2	212	75	1800
	3.96 ... 158.00	174.4	4206	5047		72.5							

* FS = Full Scale

** Standard option

SPEEDCON is a trademark of PHOENIX CONTACT GmbH & Co. KG

Dimensional drawings: All dimensions in mm (in).



Rotational Speed Sensor ▪ Type PPC-04/12-SDS-CAB

B

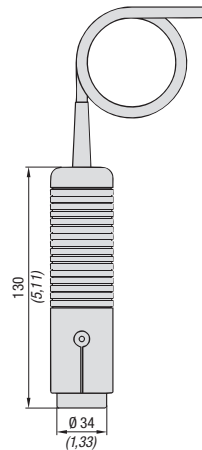

PPC-04/12-SDS-CAB

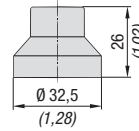

PPC-04/12-SFA-Focus Adaptor

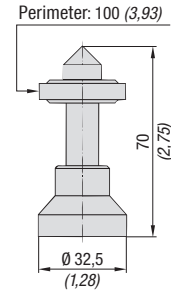

PPC-04/12-SKA-Contact Adaptor

Product Description

The PPC-04/12-SDS-CAB Rotational Speed Sensor allows non-contact speed measurement of rotating components. The sensor is based on an opto-electrical measurement principle that determines the rotational speed with high-accuracy using a reflecting strip on the shaft.

The contact rotational speed measurement is obtained by using a Contact Adaptor that is mounted to the sensor, and which makes contact with the rotating component during measurement.

This also produces high-accuracy measurement results. In the case of especially small areas, using the focusing adaptor facilities measurement.

Note: The analogue Rotational Speed Sensor PPC-04/12-SDS-CAB can only be used with analogue Hydraulic Testers.

Technical Data

- Material: ABS
- Weight: 230 g / .51 lb
- 5-pin connection
- Both contacting and non-contacting measurement possible
- Type of measurement: optical, red LED

Ambient Conditions

- Ambien temperature: 0°C ... +70 °C / +32 °F ... +158 °F

Measuring Range

- Measuring range: 20 ... 10000 1/min
- Measuring distance: 25 ... 500 mm (1 ... 20 in)
- Measuring angle: ±45 °C
- Accuracy: ≤ ±0,5 % FS*
- Resolution: ±5 1/min

Electrical Data

- Output signal: 0 ... 3 V DC
- Input signal: 7 ...12 V DC

Note: We recommended not extending the 2 m / 6.56 ft permanent cable connection provided on the sensor!

Applications Examples

Fig. 1 - Contacting rotational speed measurement with the contact adaptor

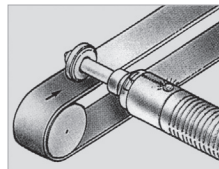

Fig. 2 - End face rotational speed measurement with the contact adaptor

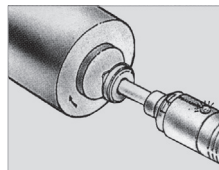
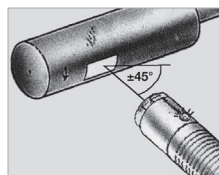
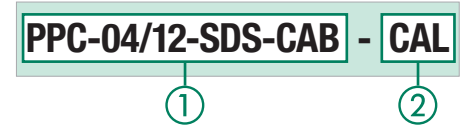

Fig. 3 - Rotating shaft / non-contacting rotational speed measurement using the focusing adaptor and marking strip



Order Codes



① **Series and Type**

Rotational Speed Sensor **PPC-04/12-SDS-CAB**

② **Calibration**

Without calibration certificate **(none)**
With calibration certificate **CAL**

Order Codes

Focus Adaptor



① **Series and Type**

Focus Adaptor **PPC-04/12-SFA-focus**

Contact Adaptor



① **Series and Type**

Contact Adaptor **PPC-04/12-SKA-contact**

Dimensional drawings: All dimensions in mm (in).



Current/Voltage/Frequency Converter ■ Type Sensorconverter-PPC



B

Order Code

Sensorconverter-PPC

①

① Series and Type

Current/Voltage/Frequency Converter

Sensorconverter-PPC

Product Description

In addition to pressure, temperature, rotational speed and flow measurements, the Hydraulic Testers can measure and evaluate different signals from other or third-party sensors.

Measuring electrical signals from third-party sensor (e.g. 4 ... 20 mA, 0 ... 10 V, ...) with the Sensorconverter-PPC.

The Sensorconverter-PPC Current/Voltage/Frequency Converter is used, for example, for measuring current at proportional valves or for determining the switching states of motors or pumps and to evaluate and process measurements from third-party sensors.

Typical applications are the generation and measurement of a force-distance graph or torque-flow characteristics curves. The following input signals can be processed by this converter:

- Electrical currents up to 4 A DC
- Electrical voltages up to 48 V DC
- Frequencies up to 5 kHz

The measured data are transmitted directly to the Hydraulic Testers by a permanent cable connection.



Connection and Extension Cables (analogue)

B

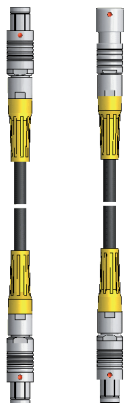

Connection Cable PPC-04/12-CAB3
Extension Cable PPC-04/12-CAB5-EXT



PC Connection Cable as a component
of the PPC-SET-PPC-04-plus-SW-CAB



PC Connection Cable as a component
of the PPC-SET-PPC-06/08-plus-SW-CAB

Product Description

Different Connection and Extension Cables for all Hydraulic Testers of the PPC series are available. These cables on the one hand, connect the sensors to the Hydraulic Testers and on the other hand connect the Hydraulic Testers with a PC or laptop. The following items are available:

Connection and Extension Cables

A PPC-04/12-CAB3 Connection Cable is required to connect the sensors to the current Hydraulic Testers PPC-04/06/08-plus or PPC Pad. The cable comes with a 5-pin push/pull connection at each end and has a length of 3 m / 9.84 ft.

Note: This cable cannot be used with older Hydraulic Testers and/or sensors (with 4-pin connection)!

The PPC-04/12-CAB5-EXT Extension Cable has a length of 5 m / 16 ft.

Note: Please keep in mind that it is generally recommended not to exceed a total cable length of 8 m / 26.25 ft!

Order Codes

PPC-04/12-CAB3

①

① Series and Type

Standard Connection Cable for Sensors	PPC-04/12-CAB3
Extension Cable	PPC-04/12-CAB5-EXT

PC Connection Cable and PC Software

A PC set, consisting of a USB connecting lead (1 m / 3.28 ft) and the corresponding PC software.

Note: The appropriate PC set is included when purchasing a PPC-04-plus and /or PPC-04-plus-CAN Hydraulic Tester.

Order Code

PC-SET-PPC-04-plus-SW-CAB

①

① Series and Type

PC Set	PC-SET-PPC-04-plus-SW-CAB
--------	----------------------------------

PC Connection Cable and PC Software

A PC set, consisting of a USB connecting lead (1,5 m / 4.92 ft) and the corresponding PC software.

Note: The appropriate PC set is included when purchasing a PPC-06/08-plus and/or PPC-Pad Hydraulic Testers.

Order Code

PC-SET-PPC-06/08-plus-SW-CAB

①

① Series and Type

PC Set	PPC-SET-PPC-06/08-plus-SW-CAB
--------	--------------------------------------





CAN Connection Cable PPC-CAN-CAB



CAN Y-Splitter Cable PPC-CAN-CAB-Y



CAN Terminating Resistor PPC-CAN-R

Product Description

To connect the CAN bus sensors to the CAN Hydraulic Testers are different cable lengths are available, depending on customers requirements. The CAN sensors work on a bus system as displayed in the connection overview on page 32. All connections are 5-pin SPEEDCON connection plugs. The following items are available:

CAN Connection Cable

The CAN Connection Cable is available in different lengths between 0,5 m / 1.64 ft and 20 m / 65.62 ft.

CAN Y-Splitter Cable

To connect a new sensor to the CAN bus, a CAN Y-Splitter Cable is necessary.

CAN Terminating Resistor

Each sensor on the end of a CAN bus has to be closed with a CAN Terminating Resistor. The resistor is also necessary when only one sensor is used.

Order Codes

PPC-CAN - CAB2

①

②

① Series and Type

 CAN Connection Cable **PPC-CAN**

② Length

0,5 m / 1.64 ft	CAB0.5
2 m / 6.65 ft	CAB2
5 m / 16.40 ft	CAB5
10 m / 32.81 ft	CAB10
20 m / 65.62 ft	CAB20

Order Code

PPC-CAN-CAB-Y

①

① Series and Type

 CAN Y-Splitter Cable 0,3 m / .98 ft **PPC-CAN-CAB-Y**

Order Code

PPC-CAN-R

①

① Series and Type

 CAN Terminating Resistor **PPC-CAN-R**

Product Description

Measuring Frequency with PPC-CAN-FR

The PPC-CAN-FR can be used to connect frequency signals (e.g. from turbines, flow counters or tachometers) to the PPC-Pad or PPC-04-plus-CAN. The instruments can process sinus and rectangle signals from 1 Hz to 5 KHz with signal amplitude from 20 mV to 10 V. Configuration is possible via USB and PC software.

Power Supply for External Sensors

An external sensor can be supplied with 24 V using the PPC-CAN-FR.

Analogue or CAN Output

The PPC-CAN-FR can be connected either to an analogue input or CAN input.

CAN Frequency Converter

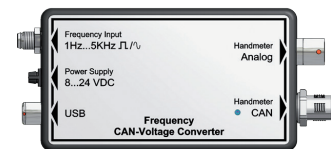

CAN Frequency Converter PPC-CAN-FR

Order Code

PPC-CAN-FR

①

① Series and Type

 CAN Frequency Converter **PPC-CAN-FR**

Technical Data

Dimensions

- 114 x 64 x 26 mm / 4.49 x 2.52 x 1.02 in

Ambient Conditions

- Operating temperature: 0 °C ... +60 °C / +32 °F ... +140 °F
- Storage temperature: -25 °C ... +70 °C / -13 °F ... +158 °F
- Relative humidity: < 80 %

Electrical Data

- Measuring range: 1 Hz ... 5 KHz
Sinus and rectangle signals
40 m V pp ... 10 V pp
- Sensor power supply: 24 V DC ± 0,5 V DC
- $I_{Out(Max)}$ without power supply: 50 mA

- $I_{Out(Max)}$ power supply at 24 V DC: 100 mA
- Accuracy: ±1 % FS* ± 0,05 % / °C

Power Supply

- Power supply (external): 8 ... 24 V DC

Electrical Connection

- Sensor: 4-pin, M8, plug
(Female with screw-in connections included with standard option)
- External power supply: 3-pin, female
- USB: 4-pin, female
- Analogue: 5-pin, female
- CAN: 5-pin, M12

* FS = Full Scale

SPEEDCON is a trademark of PHOENIX CONTACT GmbH & Co. KG



Complete Systems for analogue Hydraulic Testers PPC-04/06/08-plus



Complete Systems PPC-06/08-plus



Complete Systems PPC-04-plus

B

Product Description

Complete systems for analogue Hydraulic Testers are assembled in different versions according to customer wishes. The complete systems are supplied in a handy case with individually designed pockets/sections and have space for the components listed below.

Components

Standard Options for Complete Systems PPC-04-plus

- 1x Hydraulic Tester PPC-04-plus
- 1x Power supply incl. country-specific adaptor
- Up to 3 Pressure Sensors PPC-04/12-P with installed adaptors for STAUFF Test 20 (M16 x 2)
- Up to 2 Connection Cables (3 m / 9.84 ft)
- 1x Temperature Sensor PPC-04/12-T-M02 with installed SGV-16S-G-W3 (optional)
- 3x Adaptors SAD for the STAUFF Test 15/12/10 series (standard for all PPC complete systems)
- 1x Operating instructions (multilingual) on CD
- 1x PC software for PPC-04-plus
- 1x PC connection cable

Standard Options for Complete Systems PPC-06/08-plus

- 1x Hydraulic Tester PPC-06-plus or PPC-08-plus
- 1x Power supply incl. country-specific adaptor
- Up to 3 Pressure Sensors with installed adaptors STAUFF Test 20 (M16 x 2)
- Up to 3 Connection Cables (3 m / 9.84 ft)
- 1x Temperature Sensor PPC-04/12-T-M02 with installed SGV-16S-G-W3 (optional)
- 3x Adaptors SAD for the STAUFF Test 15/12/10 series (standard for all PPC complete systems)
- 1x Printed operating instructions (German and English)
- 1x Operating instructions (multilingual) on CD
- 1x PC software for PPC-06/08-plus
- 1x PC connection cable

Note: Please contact STAUFF for calibrated version.

Order Codes

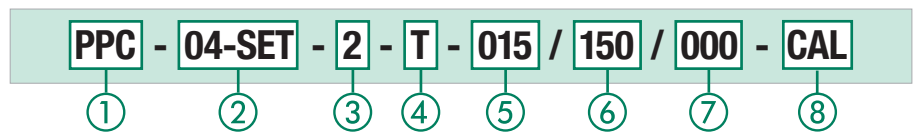

① Series and Type

Hydraulic Tester **PPC**

② Version

2 sensor inputs, incl. PC software and PC connection cable **04-SET**

3 sensor inputs, incl. PC software and PC connection cable **06-SET**

4 sensor inputs, incl. PC software and PC connection cable **08-SET**

③ Number of Pressure Sensors

With 1 Pressure Sensor **1**

With 2 Pressure Sensors **2**

With 3 Pressure Sensors **3**

④ Temperature Sensor

Without Temperature Sensor T and SGV **(none)**

With Temperature Sensor T and SGV **T**

⑤ Pressure Range and Pressure Sensor

1. Pressure Sensor **see table**

⑥ Pressure Range and Pressure Sensor

2. Pressure Sensor **see table**

⑦ Pressure Range and Pressure Sensor

3. Pressure Sensor **see table**

⑧ Calibration

Without calibration certificate **(none)**

With calibration certificate **CAL**

Pressure Range and Pressure Sensor

Pressure Range	Pressure Sensor		
000	When ordering a complete system with one or two pressure sensors, specify „000“ for the pressure range of the 2. and / or 3. pressure sensors.		
015	Pressure Range 1. Pressure Sensor	Pressure Range 2. Pressure Sensor	Pressure Range 3. Pressure Sensor
060			
150			
400			
600			
601			
e.g.	015 (15 bar)	060 (60 bar)	000 (0 bar)

Please keep in mind that two pressure sensors with identical measuring ranges are necessary for differential pressure measurements.



Complete Systems ■ Type PPC-04-CAN-SET

B



Complete Systems PPC-04-CAN-SET

Order Codes

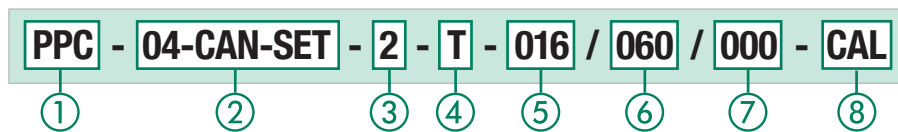

① Series and Type

 Hydraulic Tester **PPC**

② Version

 CAN version with
CAN interface **04-CAN-SET**

③ Number of CAN Pressure Sensors

 With one CAN Pressure Sensor **1**
 With two CAN Pressure Sensors **2**
 With three CAN Pressure Sensors **3**

④ CAN-Temperature Sensor

 Without CAN-Temperature Sensor T and SGV **(none)**
 With CAN-Temperature Sensor T and SGV **T**

⑤ Pressure Range and Pressure Sensors

 1. CAN Pressure Sensor **see table**

⑥ Pressure Range and Pressure Sensors

 2. CAN Pressure Sensor **see table**

⑦ Pressure Range and Pressure Sensors

 3. CAN Pressure Sensor **see table**

⑧ Calibration

 Without calibration certificate **(none)**
 With calibration certificate **CAL**

Product Description

Complete Systems for Hydraulic Testers PPC-04-plus-CAN are assembled in different versions according to customer wishes. The complete systems are supplied in a handy case with individually designed pockets/sections and have space for the components listed below.

Components

Standard Options for Complete Systems PPC-04-plus-CAN

- 1x Hydraulic Tester PPC-04-plus-CAN
- 1x Power Supply incl. country-specific Adaptor
- Up to 3 CAN Pressure Sensors PPC-CAN-P with installed Adaptors for STAUFF Test 20 (M16 x 2)
- 1x CAN Temperature Sensor PPC-CAN-T-M02 with installed SGV-16S-G-W3 (optional)
- 3x Adaptors SAD for the STAUFF Test 15/12/10 series (standard for all PPC complete systems)
- Up to 3 CAN Connecting Cables
- Up to 2 CAN Y-Splitter Cables
- 1x CAN Terminating Resistor
- 1x Operating instructions (multilingual) on CD
- 1x PC software
- 1x PC connection cable

Note: Please contact STAUFF for calibrated version.

Pressure Range and CAN Pressure Sensor

Pressure Range	CAN Pressure Sensor		
000	When ordering a complete system with one or two CAN pressure sensors, specify „000“ for the pressure range of the 2. and / or 3. CAN pressure sensors.		
016	Pressure Range 1. CAN Pressure Sensor	Pressure Range 2. CAN Pressure Sensor	Pressure Range 3. CAN Pressure Sensor
060			
160			
400			
600			
601			
e.g.	016 (16 bar)	060 (60 bar)	000 (0 bar)

Please keep in mind that two CAN pressure sensors with identical measuring ranges are necessary for differential pressure measurements.



Complete Systems ■ Type PPC-Pad-SET

B



Complete Systems PPC-Pad-SET

Product Description

The PPC Pad is also available in a special designed case to store your unit and your accessories. The case is robust, lightweight and can be carried directly to your machine.

It has individually designed inserts that can hold up to 4 Pressure Sensors, 1 CAN Flow Turbine, 1 Flow Turbine, 1 Frequency- and 1 Aux.-Adaptor. Cable and additional equipment also have their own place inside.

PPC Pad case is the best way to store and protect your equipment.

Standard PPC-Pad-SET kits have been put together to equip an user with the basic equipment needed for basic measurement.

Components

Standard Options for Complete Systems PPC-Pad-SET

- Hydraulic Tester PPC Pad
- Installed Handle
- 24 V DC / 2,5 A Power supply incl. country-specific adaptor
- M8 x 1 / 4-pin (digital in/out)
- USB 2.0 cable (2 m / 6.56 ft)
- LAN cable (5 m / 16.40 ft)
- Operating Instructions
- PC software
- MicroSD memory card
- Equipment case
- Neck strap
- CAN Connection Cable (5 m / 16.40 ft)
- 2x CAN Terminating Resistor
- Analogue Connection Cable (3 m / 9.84 ft)
- M12 cable socket Aux. output

Order Codes

PPC-Pad	- SET-101	- CAL
①	②	③
① Series and Type		
Hydraulic Tester		PPC-Pad
② Version		
PPC-Pad-SET-101		SET-101
PPC-Pad-SET-102		SET-102
PPC-Pad-SET-103		SET-103
③ Calibration (only -102 / -103)		
Without calibration certificate		(none)
With calibration certificate		CAL

Version PPC-Pad-Set

Version	Hydraulic Tester	CAN Sensor Inputs	Sensor Inputs with Sensor Recognition STAUFF (Analogue)	Aux. Sensor Inputs (Analogue)	Case	Neck Strap	CAN Connection Cable 5m / 16.40 ft	CAN Terminating Resistor	Analogue Connection Cable 3m / 9.84 ft	Aux. Sensor Inputs - Cable Adaptor
PPC-Pad-SET-101	PPC-Pad-101	2 networks each with max. 8 sensors	-	-	1	1	2	2	-	-
PPC-Pad-SET-102	PPC-Pad-102		3	2	1	1	2	2	2	1
PPC-Pad-SET-103	PPC-Pad-103		6	4	1	1	2	2	3	2



Ordering Table for analogue Hydraulic Test Equipment

Series	Descriptions	Order Codes	Pages
1. Hydraulic Testers	Hydraulic Tester PPC-04-plus with 2 sensor inputs, incl. accessories	PPC-04-plus	28
	Hydraulic Tester PPC-06-plus with 3 sensor inputs, incl. accessories	PPC-06-plus	29
	Hydraulic Tester PPC-08-plus with 4 sensor inputs, incl. accessories	PPC-08-plus	
2. Pressure Measurement	Pressure Sensors G1/4 (without Adaptor)		
	Pressure range from -1 ... 15 bar / -14.5 ... 217 PSI relative pressure	PPC-04/12-P-015	34
	Pressure range from 0 ... 60 bar / 0 ... 870 PSI absolute pressure	PPC-04/12-P-060	
	Pressure range from 0 ... 150 bar / 0 ... 2175 PSI absolute pressure	PPC-04/12-P-150	
	Pressure range from 0 ... 400 bar / 0 ... 5801 PSI absolute pressure	PPC-04/12-P-400	
	Pressure range from 0 ... 600 bar / 0 ... 8702 PSI absolute pressure	PPC-04/12-P-600	
Pressure range from 0 ... 600 bar / 0 ... 8702 PSI absolute pressure *	PPC-04/12-P-601		
3. Temperature Measurement	Temperature Sensors (-40 °C ... +150 °C / -40 °F ... +302 °F)		
	Screw-in Temperature Sensor for pipeline installation (M10x1)	PPC-04/12-T-M02	36
	Screw-in Temperature Sensor for pipeline installation (G1/4)	PPC-04/12-T-B02	
	Rod-type Temperature Sensor for tank / container measurements	PPC-04/12-TSH	
	Straight threaded Adaptor with M10 x 1 connection (for PPC-04/12-T-M02)	SGV-16S-G-W3	
Pressure/ Temperature Sensors G1/2 (without Adaptor)			
4. Pressure/ Temperature Measurement	Pressure range from -1 ... 15 bar / -14.5 ... 217 PSI relative pressure	PPC-04/12-PT-015	38
	Pressure range from 0 ... 60 bar / 0 ... 870 PSI absolute pressure	PPC-04/12-PT-060	
	Pressure range from 0 ... 150 bar / 0 ... 2175 PSI absolute pressure	PPC-04/12-PT-150	
	Pressure range from 0 ... 400 bar / 0 ... 5801 PSI absolute pressure	PPC-04/12-PT-400	
	Pressure range from 0 ... 600 bar / 0 ... 8702 PSI absolute pressure	PPC-04/12-PT-600	
	Pressure range from 0 ... 600 bar / 0 ... 8702 PSI absolute pressure *	PPC-04/12-PT-601	
5. Connection Adaptors for PPC Sensors	Connection Adaptors		
	Adaptor G1/4 to M16 x 2 (STAUFF Test 20)	SDA-20-G1/4-W3	34 / 38
	Adaptor G1/2 to M16 x 2 (STAUFF Test 20)	SDA-20-G1/2-W3	
	Adaptor M16 x 2 to M16 x 1,5 (STAUFF Test 20 to STAUFF Test 15)	SAD-20/15-B-W3	
	Adaptor M16 x 2 to S12,65 x 1,5 (STAUFF Test 20 to STAUFF Test 12)	SAD-20/12-B-W3	
Adaptor M16 x 2 to plug-in (STAUFF Test 20 to STAUFF Test 10)	SAD-20/10-B-W3		
6. Flow Measurement	Flow Turbines with integrated Signal Converter		
	Measuring range from 1 ... 15 l/min / .3 ... 3.9 US GPM	PPC-04/12-SFM-015	40
	Measuring range from 4 ... 60 l/min / 1 ... 15.9 US GPM	PPC-04/12-SFM-060	
	Measuring range from 6 ... 150 l/min / 1.6 ... 39.6 US GPM	PPC-04/12-SFM-150	
	Measuring range from 10 ... 300 l/min / 2.7 ... 79 US GPM	PPC-04/12-SFM-300	
Measuring range from 20 ... 600 l/min / 5.3 ... 158 US GPM	PPC-04/12-SFM-600		
7. Rotational Speed Measurement	Rotational Speed Sensor with integrated Connection Cable 2 m / 6.56 ft	PPC-04/12-SDS-CAB	42
	Contact Adaptor	PPC-04/12-SKA-contact adaptor	
	Focus Adaptor	PPC-04/12-SFA-focus adaptor	
8. Current / Voltage / Frequency Converter / Third-party Sensors	Current / Voltage / Frequency Converter / Third-party Sensor (up to 4 A DC / 48 V DC / 5 kHz)	Sensorconverter-PPC	43
9. Accessories (Connection / Extension Cables and Software)	Connection Cable 3 m / 9.84 ft (5-pin push/pull connection on both sides)	PPC-04/12-CAB3	44
	Extension Cable 5 m / 16.40 ft 5-pin push/pull connection on both sides)	PPC-04/12-CAB5-EXT	
	PC Connection Cable and PC Software for PPC-04-plus	PC-SET-PPC-04-plus-SW-CAB	
	PC Connection Cable and PC Software for PPC-06/08-plus	PC-SET-PPC-06/08-plus-SW-CAB	
10. Ersatzteile / Komplettsysteme	Case PPC-04-plus (with foam insert)	PPC-04-plus case	46
	Case PPC-06/08-plus (with foam insert)	PPC-06/12 case	
	Power Supply (110/230 V AC) for PPC-04-plus with USB connections, incl. country-specific adaptor	PPC-04-plus-110V/230V-USB	
	Power Supply (110/230 V AC) for PPC-06/08-plus, incl. country-specific adaptor	PPC-04/12-110V/230V	
	Complete Systems for Analogue Hydraulic Testers PPC-04/06/08-plus, Order Codes on page 46		

All available individual components for analogue Hydraulic Testers PPC-04-plus, PPC-06-plus and PPC-08-plus, with their order codes, are listed below. They can be configured by the customer using this form.

In the list, the components are sorted according to application areas/tasks to provide a better overview. For custom kits, please contact STAUFF.

* Pressure peaks up to 1000 bar / 14500 PSI

All hydraulic testers and sensors are available in calibrated version. Please add -CAL to the order code.

B

Ordering Table for CAN Hydraulic Test Equipment

All available components for CAN Hydraulic Testers, with their order codes, are listed below. They can be configured by the customer using this form.

In the list, the components are sorted according to application areas/tasks to provide a better overview.

For custom kits, please contact STAUFF.

* Pressure peaks up to 1000 bar / 14500 PSI

All CAN Hydraulic Testers (except PPC-04-plus-CAN and PPC-Pad-101) and sensors are available as calibrated versions. Please add -CAL to the order code.

Series	Descriptions	Order Codes	Pages
1. CAN Hydraulic Testers	CAN Hydraulic Tester PPC-04-plus-CAN with CAN interface, incl. accessories	PPC-04-plus-CAN	28
	CAN Hydraulic Tester PPC-Pad-101 with 2 CAN networks, incl. accessories	PPC-Pad-101	30
	CAN Hydraulic Tester PPC-Pad-102 with 2 CAN networks and 3 analogue sensor inputs, incl. accessories	PPC-Pad-102	
	CAN Hydraulic Tester PPC-Pad-103 with 2 CAN networks and 6 analogue sensor inputs, incl. accessories	PPC-Pad-103	
2. Pressure Measurement	CAN Pressure Sensors G1/4 (without Adaptor)		
	Pressure range from -1 ... 16 bar / -14.5 ... 232 PSI relative pressure	PPC-CAN-P-016	35
	Pressure range from 0 ... 60 bar / 0 ... 870 PSI absolute pressure	PPC-CAN-P-060	
	Pressure range from 0 ... 160 bar / 0 ... 2321 PSI absolute pressure	PPC-CAN-P-160	
	Pressure range from 0 ... 400 bar / 0 ... 5801 PSI absolute pressure	PPC-CAN-P-400	
	Pressure range from 0 ... 600 bar / 0 ... 8702 PSI absolute pressure	PPC-CAN-P-600	
Pressure range from 0 ... 600 bar / 0 ... 8702 PSI absolute pressure *	PPC-CAN-P-601		
3. Temperature Measurement	CAN-Temperature Sensors (-40 °C ... +150 °C / -40 °F ... +302 °F)		
	Screw-in Temperature Sensor for pipeline installation (M10x1)	PPC-CAN-T-M02	37
	Screw-in Temperature Sensor for pipeline installation (G1/4)	PPC-CAN-T-B02	
Straight threaded Adaptor with M10 x 1 connection (for PPC-CAN-T-M02)	SGV-16S-G-W3		
4. Pressure/ Temperature Measurement	CAN Pressure/ Temperature Sensors G1/2 (without Adaptor)		
	Pressure range from -1 ... 16 bar / -14.5 ... 232 PSI relative pressure	PPC-CAN-PT-016	39
	Pressure range from 0 ... 60 bar / 0 ... 870 PSI absolute pressure	PPC-CAN-PT-060	
	Pressure range from 0 ... 160 bar / 0 ... 2321 PSI absolute pressure	PPC-CAN-PT-160	
	Pressure range from 0 ... 400 bar / 0 ... 5801 PSI absolute pressure	PPC-CAN-PT-400	
	Pressure range from 0 ... 600 bar / 0 ... 8702 PSI absolute pressure	PPC-CAN-PT-600	
Pressure range from 0 ... 600 bar / 0 ... 8702 PSI absolute pressure *	PPC-CAN-PT-601		
5. Connection Adaptors for PPC Sensors	Connection Adaptors		
	Adaptor G1/4 to M16 x 2 (STAUFF Test 20)	SDA-20-G1/4-W3	35 / 39
	Adaptor G1/2 to M16 x 2 (STAUFF Test 20)	SDA-20-G1/2-W3	
	Adaptor M16 x 2 to M16 x 1,5 (STAUFF Test 20 to STAUFF Test 15)	SAD-20/15-B-W3	
	Adaptor M16 x 2 to S12,65 x 1,5 (STAUFF Test 20 to STAUFF Test 12)	SAD-20/12-B-W3	
Adaptor M16 x 2 to plug-in (STAUFF Test 20 to STAUFF Test 10)	SAD-20/10-B-W3		
6. Flow Measurement	CAN Flow Turbines with integrated Signal Converter		
	Measuring range from 1 ... 15 l/min / .3 ... 3.9 US GPM	PPC-CAN-SFM-015	41
	Measuring range from 4 ... 60 l/min / 1 ... 15.9 US GPM	PPC-CAN-SFM-060	
	Measuring range from 6 ... 150 l/min / 1.6 ... 39.6 US GPM	PPC-CAN-SFM-150	
	Measuring range from 10 ... 300 l/min / 2.7 ... 79 US GPM	PPC-CAN-SFM-300	
Measuring range from 20 ... 600 l/min / 5.3 ... 158 US GPM	PPC-CAN-SFM-600		
7. CAN Accessories	CAN Connection Cable 0,5 m / 1.64 ft	PPC-CAN-CAB0.5	45
	CAN Connection Cable 2 m / 6.65 ft	PPC-CAN-CAB2	
	CAN Connection Cable 5 m / 16.40 ft	PPC-CAN-CAB5	
	CAN Connection Cable 10 m / 32.81 ft	PPC-CAN-CAB10	
	CAN Connection Cable 20 m / 65.62 ft	PPC-CAN-CAB20	
	CAN Y-Splitter Cable 0,3 m / .98 ft	PPC-CAN-CAB-Y	
	CAN Terminating Resistor	PPC-CAN-R	
8. Connection Cable and Accessories	PC Connection Cable and PC Software for PPC-04-plus-CAN	PC-SET-PPC-04-plus-SW-CAB	44
9. CAN Frequency Converter	CAN Frequency Converter	PPC-CAN-FR	45
10. Spare Parts and Complete Systems	Complete Systems for CAN Hydraulic Tester PPC-04-plus-CAN, Order Codes on page 47		
	Case PPC-04-plus-CAN (with foam insert)	PPC-04-plus case	47
	Power Supply (110/230 V AC) for PPC-04-plus-CAN with USB connection, incl. country-specific Adaptor	PPC-04-plus-110V/230V-USB	
	Case PPC-Pad (with foam insert)	PPC-Pad case	
	Complete System PPC-Pad-SET-101 with 2 CAN networks, incl. accessories, case, CAN Connection Cable	PPC-Pad-SET-101	48
	Complete System PPC-Pad-SET-102 with 2 CAN networks and 3 analogue sensor inputs, incl. accessories, case, CAN Connection Cable	PPC-Pad-SET-102	
Complete System PPC-Pad-SET-103 with 2 CAN networks and 6 analogue sensor inputs, incl. accessories, case, CAN Connection Cable	PPC-Pad-SET-103		





The PT-RF series of pressure transmitters are an alternative solution for universal pressure measurements for fluid technology applications, which will provide benefits for system operators, maintenance personnel and repair technicians as well as for original equipment manufacturers.

The advantages resulting from the use of the new technology for system operators, maintenance personnel and repair technicians are clear:

Measurements can be carried very easily, without extensive training and within a few seconds at the press of a button and then documented in a reliable process.

Unscrewing and re-installing pressure gauges or other measuring and display devices – practically a temporary opening of the system – is not required. Potential hazards for people, machines and the environment, for example from emitted residual oil in the test hose or leaks at the measuring point, as well as ingress of dirt into the system (e.g. in dusty environments) can be effectively excluded.

Original equipment manufacturers will also benefit from this new technology: If the pressure transmitters are installed at their factory already, the innovative technology can provide a competitive edge over alternative suppliers and open up specific advantages for the users, increasing the value retention of their own devices in the long term.

If the pressure transmitters are installed directly in the system or pipeline for permanent use, they protrude only slightly more than conventional hydraulic test couplings and meet the highest demands with regard to space requirements and weight.



Pressure Transmitter - Type PT-RF

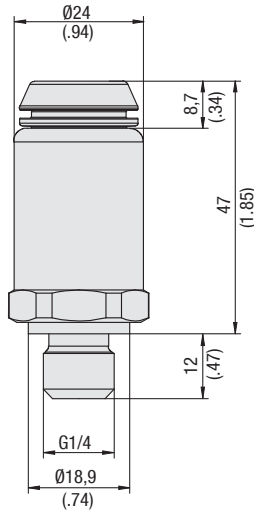

Process connection G1/4 (B04)

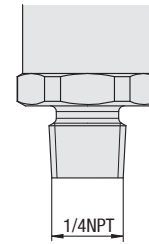

Process connection 1/4NPT (N04)

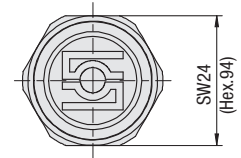

B

Product Description

The pressure transmitters from the PT-RF series are integrated into fluid technology plants and systems permanently or temporarily using the appropriate process connection adapters. The energy required for a measurement is transferred to the pressure transmitter via the antenna of the reading device using wireless RFID technology. This means that the pressure transmitters require neither internal nor external power supply and are completely maintenance-free.

Technical Data

Wetted Parts

- Suitable for liquid and gaseous media

Materials

- Housing: Stainless Steel 1.4305
- Sealing (B04): FKM (Viton®)
- Cap: Polyamide (glass fibre-reinforced)

Dimensions / Weight

- Dimensions: 59 x 26 mm / 2.32 x 1.02 in
- Weight: 80 g / .18 lbs

Temperature Range

- Media temp. (N04): -40°C ... +135°C / -40°F ... +275°F
- Media temp. (B04): -30°C ... +135°C / -22°F ... +275°F
- Ambient temp.: -40°C ... +85°C / -40°F ... +185°F
- Storage temp.: -55°C ... +125°C / -67°F ... +257°F

Electrical Data

- Sampling rate: typ. 250 ms / max. 400 ms according to IEC EN 60770-1
- Long-term stability: max. ± 0,25 % FS* / a
- Load cycles (10⁶): 10
- Vibration loading: acc. to IEC 60068-2-6 (20 g)
- Shock loading: acc. to IEC 60068-2-27 (30 g) 11ms

Protection Rating

- IP69 protection rating: Dust tight and protected against high-pressure and steam cleaning

Order Codes

PT - RF - B00600 - B04

① ② ③ ④

① Series and Type Pressure Transmitter	PT
② Version Signal transmission via RFID technology	RF
③ Pressure Range	see table
④ Process Connection	B04 G1/4 N04 1/4 NPT

Pressure Range and Accuracies

Version	Pressure Range and Accuracies					
Pressure Transmitter PT-RF	Pressure Range (bar/PSI)	Type of Measurement	Maximum Pressure (bar/PSI)	Burst Pressure (bar/PSI)	Accuracy (±% FS*) typ.	Accuracy (±% FS*) max.
B00016	0 ... 16	Relative pressure	32	48	0,25	0,5
	0 ... 232		464	696		
B00060	0 ... 60	Relative pressure	120	180	0,25	0,5
	0 ... 870		1740	2610		
B00160	0 ... 160	Relative pressure	320	480	0,25	0,5
	0 ... 2320		4641	6961		
B00400	0 ... 400	Relative pressure	800	1200	0,25	0,5
	0 ... 5801		11603	17405		
B00600	0 ... 600	Relative pressure	1200	1800	0,25	0,5
	0 ... 8702		17404	26107		

Temperature behaviour: max. ± 0,2 % FS* /10K (test condition 25 °C; 45 % v. F.)

* FS = Full Scale

Process Connection Adaptors for Pressure Transmitter PT-RF

Various adaptors are available in addition to the pressure transmitters from the PT-RF series, allowing connection to the known STAUFF Test 20 system as well as installation in pipes.



SDA-20-G1/4-W3
Adaptor for process connection G1/4 (B04) on test coupling STAUFF Test 20 (connection thread M16 x 2)



SRS-G1/4-*-V-G-W3**
Straight fitting with adaptor
Note: Please replace *** with tube-Ø and series (L or S).



SMD-20-1/4NPT-W3
Adaptor for process connection 1/4NPT (N04) on test coupling STAUFF Test 20 (connection thread M16 x 2)

Dimensional drawing: All dimensions in mm (in).



Reader ■ Type Reader-PT-RF



B

Order Code

Reader-PT-RF

①

① Series and Type

 Reader **Reader-PT-RF**

Standard option:

- Reader-PT-RF
- Manual and software on CD
- Quick guide
- USB 2.0 cable (1 m / 3.28 ft)
- 5 V DC / 1 A power supply incl. country-specific adaptors

Technical Data

Material

- Housing made of ABS

Dimensions / Weight

- Dimensions: 76 x 35 x 240 mm / 3.0 x 1.38 x 9.45 in
- Weight: 220 g / .49 lbs

Measurements / Display

- Pressure: in bar and PSI
- Temperature: in °C and °F
- Display: graphic, LED backlight
- Visible area: 55 x 46 mm / 2.17 x 1.81 in
- Resolution: 128 x 64 Pixel

Set Up

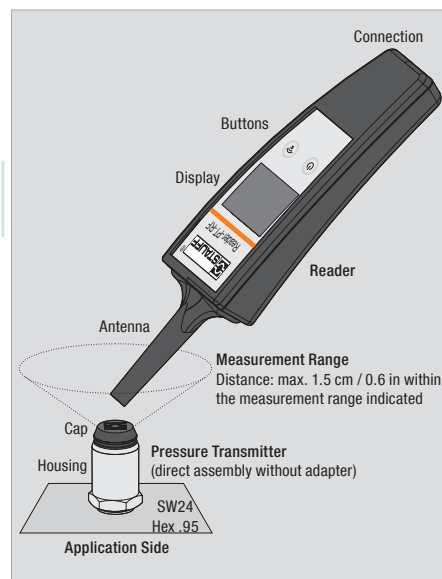

Power Supply

- Battery: Lithium Ion (3,7 V DC / 900 mAh)
- Operating time approx. 6h (approx. 1800 individual measurement)

Temperature Range

- Ambient temp.: -20 °C ... +70 °C / -4 °F ... +158 °F
- Storage temp.: -25 °C ... +60 °C / -13 °F ... +140 °F
- CE certified

Product Description

The hand-held readers transfer the energy required for a measurement to the pressure transmitter using RFID technology. All that is required is a maximum distance of 1.5 cm / 0.6 in from the antenna to the tip of the pressure transmitter for the duration of the measurement.

When the pressure transmitter is activated by the press of a button, a current measured value is determined within only 0.5 seconds and then immediately transmitted back to the reading device together with other relevant information and then output on the illuminated display and stored. Over 15,000 of these measurement sets can be stored in the internal memory of the device.

PC Software

The software included with the delivery allows transmission of the stored measured values from the reading device to the PC, subsequent evaluation and export, e.g. to Microsoft Excel®.

Electrical Data / Interface

- Sampling rate: typ. 250 ms / max. 400 ms
- Interface: Micro USB
- EMV: EN 61326-1:2013
EN 300330

Protection Rating

- IP65 protection rating: Dust tight and protected against water jets

Type of Measurement

Start Measurement

1. Switch on the reader using the function button.

During the brief start process, the charge state of the lithium ion battery (Battery) is shown on the display and the share of the currently occupied data memory (MemUsed) in percent as well as the current date and time.

2. Position the tip of the antenna of the reader inside the measurement range of the pressure transmitter and hold this position as long as possible during the entire measurement process.

Individual Measurement (Single Value)

3. Start the individual measurement by tapping the function button once.

Permanent Measurement (Multiple Values)

3. Start the permanent measurement by holding down the function button.

The simplest way of recognising the successful start of a permanent measurement is the change in the corresponding symbol in the upper right-hand corner of the display. The absolute number of the values determined as part of the measurement process is shown below the current pressure.

4. End a continuous measurement by releasing the function key.

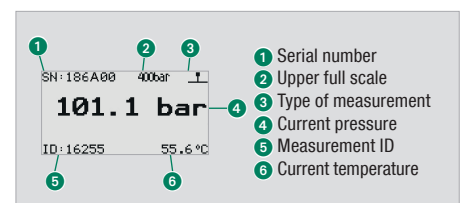

Display after successful individual measurement

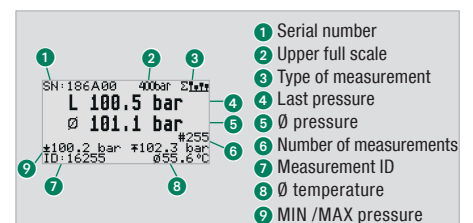

Display after successful permanent measurement



Complete system ▪ Type PT-RF-SET



Complete system in case PT-RF-SET



B

Product Description

The PT-RF-SET complete system is compiled in different versions according to customer requirements. All complete systems are supplied in a handy carrying case containing individually shaped foam inserts for a maximum of 10 pressure transmitters and 10 process connection adaptors and offering space for the following components:

Standard Option

- 1x Reader-PT-RF
- up to 3 Pressure Transmitters PT-RF
- up to 3 Process Connection Adaptors SDA or SMD
- 1x Manual and Software on CD
- 1x Quick Guide
- 1x USB 2.0 cable(1 m / 3.28 ft)
- 1x Power Supply incl. country-specific adaptors

Order Codes

PT-RF	-	SET	-	2	-	400	/	600	/	000	-	B		
①		②		③		④		⑤		⑥		⑦		
① Series and Type			④ Pressure Range / Version			⑤ Pressure Range / Version			⑥ Pressure Range / Version			⑦ Process Connection Adaptor		
Series PT-RF			1 st pressure transmitter			2 nd Pressure Transmitter			3 rd Pressure Transmitter			Adaptor SDA for process connection G1/4 (B04)		
PT-RF			see table			see table			see table			B		
② Version			⑤ Pressure Range / Version			⑥ Pressure Range / Version			Adaptor SMD for process connection 1/4NPT (N04)			N		
Complete system in case			2 nd Pressure Transmitter			3 rd Pressure Transmitter			Adaptor SMD for process connection 1/4NPT (N04)			N		
SET			see table			see table			N					
③ Number of Pressure Transmitters in the Set			⑦ Process Connection Adaptor											
1x pressure transmitter			Adaptor SDA for process connection G1/4 (B04)											
1			B											
2x pressure transmitter			Adaptor SMD for process connection 1/4NPT (N04)											
2			N											
3x pressure transmitter														
3														

Pressure Transmitter: Pressure Range and Version

Pressure Range	Version of Pressure Transmitter
000	When ordering a complete system with one or two pressure transmitters, the pressure range for the 2 nd and 3 rd pressure transmitter is given as "000".
016	Version pressure transmitter: B00016 (pressure range: 0 ... 16 bar / 0 ... 232 PSI)
060	Version pressure transmitter: B00060 (pressure range: 0 ... 60 bar / 0 ... 870 PSI)
160	Version pressure transmitter: B00160 (pressure range: 0 ... 160 bar / 0 ... 2320 PSI)
400	Version pressure transmitter: B00400 (pressure range: 0 ... 400 bar / 0 ... 5801 PSI)
600	Version pressure transmitter: B00600 (pressure range: 0 ... 600 bar / 0 ... 8702 PSI)
e.g.	400 (400 bar) 600 (600 bar) 000 (0 bar)

Spare Parts / Accessories



Case-Reader-PT-RF

Product Description

In addition to the Charger-Set-Reader-PT-RF which is available as a spare part, the Case-PT-RF-Set is also available as an individual item for assembling a complete system later on.

The Case-Reader-PT-RF is available if only a storage case for the reading device is required. It only provides space for the reading device and the associated accessories (without pressure transmitters and process connection adaptors).

Order Codes

Spare Parts / Accessories	
①	
① Spare Parts / Accessories	
Case, small	Case-Reader-PT-RF
Case, large	Case-PT-RF-SET
5 V DC / 1 A power supply incl. country-specific adaptors and USB 2.0 cable	Charger-Set-Reader-PT-RF
Adaptor for pressure transmitter (B04)	SDA-20-G1/4-W3
Adaptor for pressure transmitter (N04)	SMD-20-1/4NPT-W3
Straight fitting with adaptor	SRS-G1/4-***-V-G-W3



Accumulator Adaptor - Type SBAA / SDAA

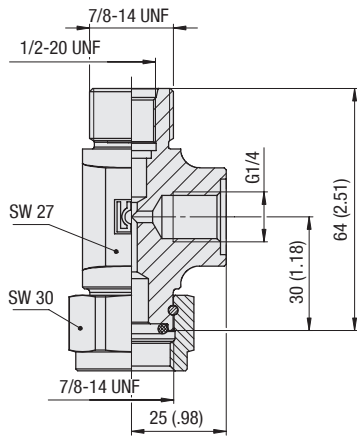

Bladder accumulator type SBAA-U05-B04

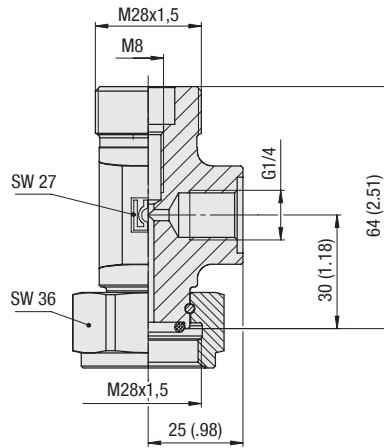

Diaphragm accumulator type SDAA-M08-B04



B

Order Codes

SBAA - U05 - B04

①

②

③

① Adaptor Type

Stauff Bladder Accumulator Adaptor	SBAA
7/8-14UNF Accumulator Connection Thread	
Stauff Diaphragm Accumulator Adaptor	SDAA
M28x1,5 Accumulator Connection Thread	

② Valve Connection Thread

1/2-20UNF (only for SBAA)	U05
M8 (only for SDAA)	M08
Other Connection Threads on request.	

③ Sensor Connection Thread

G1/4 Sensor Connection	B04
Other Connection Threads on request.	

Set Up

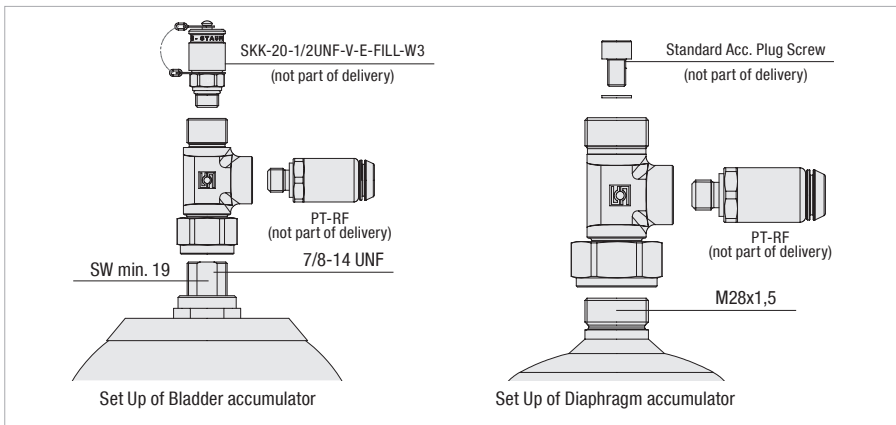

Product Description

Membrane and bladder accumulators are important components of modern hydraulic systems. Monitoring the nitrogen pressure level is becoming ever more important for ensuring correct operation.

The STAUFF Accumulator Adaptor together with the PT-RF pressure sensors allow maintenance personnel to quickly and easily check the accumulator pressure without pressure loss. Pressure values, serial numbers, date and time will automatically be stored in the memory of the reader and then easily and conveniently read out on the PC later on.

For this, the Accumulator Adaptor is screwed onto the nitrogen connection of the accumulator and a PT-RF pressure sensor is attached at the side.

The original Valve from the Accumulator can either still be used on top of the Adaptor in case it is equipped with an 1/2-20UNF thread, or be replaced by a Valve with the above thread e.g. STAUFF SKK-20-1/2UNF-V-E-FILL-W3. Charging devices already in use can still be used.

Technical Data

- max. Pressure: 400 bar / 5801 PSI
- Burst Pressure: 1600 bar / 23206 PSI
- Sealing Material: NBR (Buna-N®)

Application



Bladder accumulator in use with Reader-PT-RF



Diaphragm accumulator



Flow Indicator ▪ Types SDM / SDMKR

B

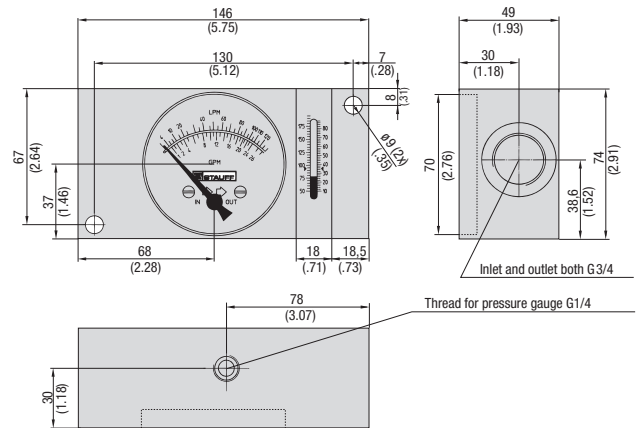

Dimensions SDM-750

Product Description

Analogue flow indicators for measuring the flow rate of fluids in mobile and industrial hydraulics. The SDMKR is designed with a loading valve for the strain test of the hydraulic system to facilitate precise control of the operating pressure. In addition, this product can also be subjected to a reverse flow direction (without flow rate determination).

Features

- Suitable for Mineral Oil (Aluminium), HFC Fluids and Water (Brass)
- Designed for in-line installation
- Mechanical flow measurement
- Controlling working pressure with a pressure control valve (only SDMKR)
- Flow indication in l/min and GPM for Aluminium units, Brass units have flow indication for Water and Oil both in l/min
- Aluminium unit: Dual scale
- Brass unit: Single scale
- Thread to connect with pressure gauge (only SDM)

Technical Data

Accuracy

(at a kinematic viscosity of 28cSt):

- Flow: ±4 % FSD
- Temperature: ±2,5 °C / ±5 °F
- Pressure (only SDMKR): ±1.6 % FS*
- Temp. measuring range: +20 °C ... +110 °C / +55 °F ... +245 °F
- Media temperature permanent: +80 °C / +176 °F temporary (<10 min.): +110 °C / +245 °F

Note: Other thread versions available on request.

Order Codes

SDM - 750 - A - 016 - T

① ② ③ ④ ⑤

① Series and Type

Flow Indicator Type SDM	SDM
Flow Indicator Type SDMKR	SDMKR

② Size

750	750
1500 (only SDM)	1500

③ Housing Material

Aluminium	A
Brass (only SDM)	B

④ Flow Ranges

See table on page 57

⑤ Thermometer

With integrated thermometer (standard option) **T**

Functional Principal Flow Measuring

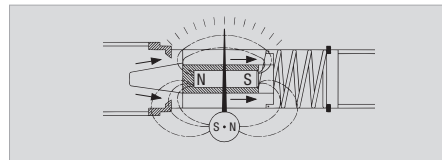

The flow indicators SDM and SDMKR have a sharp-edged orifice and a tapered metering piston, which moves in proportion to changes of flow against a spring. In no flow condition the piston closes the opening and the pointer indicates zero.

With increasing flow and differential pressure the piston moves against the calibrated spring. The piston movement is directly proportional to the flow rate and is magnetically coupled to the rotary pointer. During this function the sharp-edged orifice minimises the effects of viscosity. The flow is shown on a calibrated scale in l/min and gal/min.

Controlling Working Pressure with SDMKR

The pressure control valve of the SDMKR is directly connected to a flow-block and together with the integrated pressure gauge it allows an exact control of the working pressure in the maximum range.

For protection the SDMKR has two rupture disks. At a pressure >420 bar the disks burst and the fluid is by-passed around the valve. The rupture disks (other pressure ranges on request) can be replaced easily.

The SDMKR also permits flow in the reverse direction (without flow rate determination).



Flow Indicators - Types SDM / SDMKR

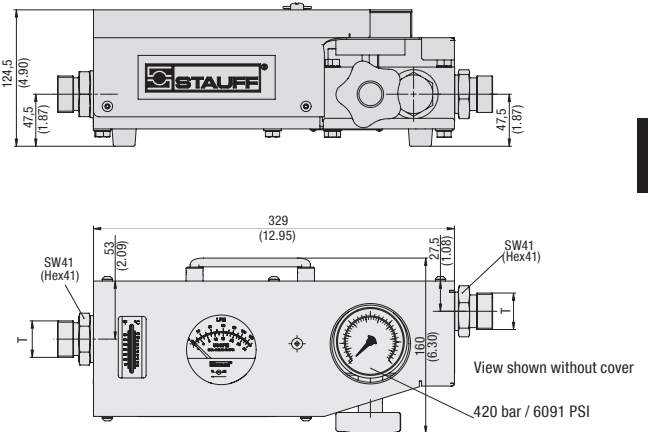
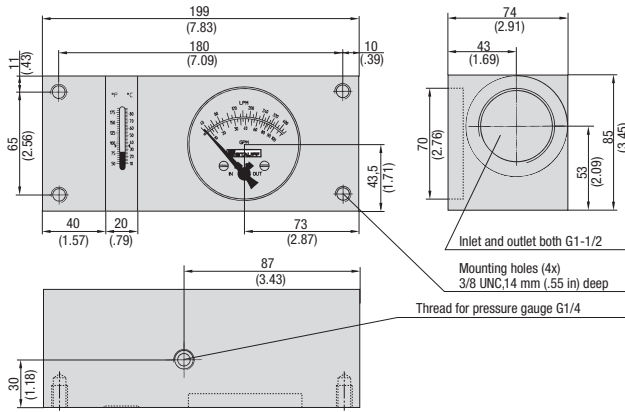

Technical Data

Max. Working Pressure (bar/PSI)	Flow Range (l/min/US GPM) Aluminum Units	Flow Range Brass Units (only SDM) *	Weight (kg/lbs)	Connection T	Order Codes
420	2 - 16	-	1,36	G3/4	SDM-750-A-016-T
6091	0.5 - 4	-	3.0	G3/4	SDM-750-A-030-T
420	2 - 30	-	1,36	G3/4	SDM-750-A-030-T
6091	0.5 - 8	-	3.0	G3/4	SDM-750-A-060-T
420	2 - 60	-	1,36	G3/4	SDM-750-A-060-T
6091	0.5 - 16	-	3.0	G3/4	SDM-750-A-120-T
420	4 - 120	-	1,36	G3/4	SDM-750-A-120-T
6091	1 - 32	-	3.0	G3/4	SDM-750-A-180-T
420	10 - 180	-	1,36	G3/4	SDM-750-A-180-T
6091	4 - 48	-	3.0	G3/4	SDM-750-B-030-T
420	-	2 - 30 l/min in oil	3,80	G3/4	SDM-750-B-030-T
6091	-	2 - 30 l/min in water	8.40	G3/4	SDM-750-B-060-T
420	-	3 - 60 l/min in oil	3,80	G3/4	SDM-750-B-060-T
6091	-	3 - 70 l/min in water	8.40	G3/4	SDM-750-B-120-T
420	-	4 - 120 l/min in oil	3,80	G3/4	SDM-750-B-120-T
6091	-	4 - 140 l/min in water	8.40	G3/4	SDM-1500-A-200-T
350	10 - 200	-	3,0	G1-1/2	SDM-1500-A-300-T
5075	5 - 50	-	6.61	G1-1/2	SDM-1500-A-300-T
350	20 - 300	-	3,0	G1-1/2	SDM-1500-A-400-T
5075	4 - 80	-	6.61	G1-1/2	SDM-1500-A-400-T
350	20 - 400	-	3,0	G1-1/2	SDM-1500-B-200-T
5075	5 - 100	-	6.61	G1-1/2	SDM-1500-B-200-T
350	-	10 - 200 l/min in oil	8,0	G1-1/2	SDM-1500-B-400-T
5075	-	10 - 200 l/min in water	17.64	G1-1/2	SDM-1500-B-400-T
350	-	20 - 400 l/min in oil	8,0	G1-1/2	SDMKR-750-A-030-T
5075	-	20 - 400 l/min in water	17.64	G1-1/2	SDMKR-750-A-060-T
420	2 - 30	-	6,6	G3/4	SDMKR-750-A-060-T
6091	0.5 - 8	-	14.55	G3/4	SDMKR-750-A-120-T
420	5 - 60	-	6,6	G3/4	SDMKR-750-A-120-T
6091	1.3 - 16	-	14.55	G1	SDMKR-750-A-200-T
420	5 - 120	-	6,6	G1	SDMKR-750-A-200-T
6091	1.3 - 32	-	14.55	G1	
420	10 - 200	-	6,6	G1	
6091	4 - 53	-	14.55	G1	

Flow Curves - Aluminium Version (Oil)

(Curves refer to kinematic viscosity of 25cSt):

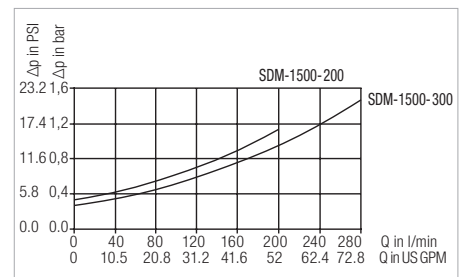
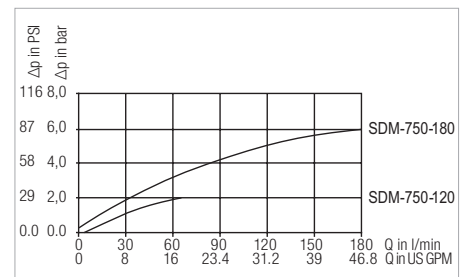
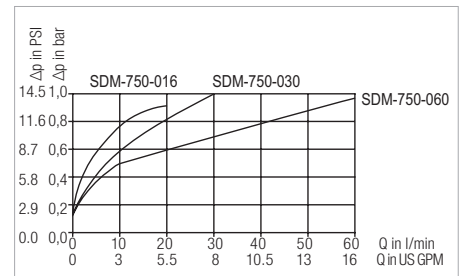



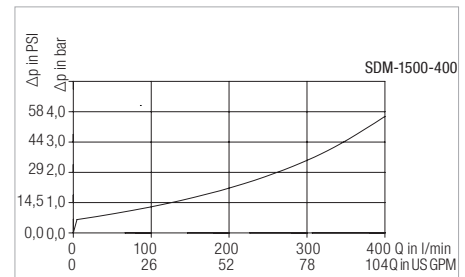
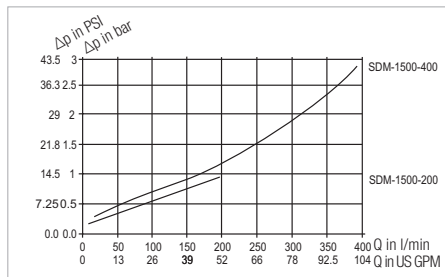
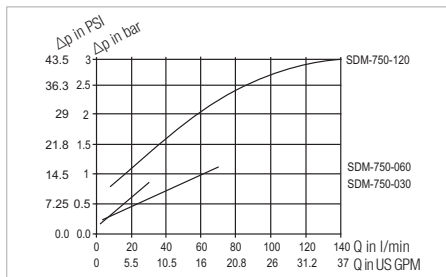









Flow Curves - Brass Version (Water)



* The Brass units have a scale for water and oil – l/min.
Dimensional drawings: All dimensions in mm (in).





Overview	60	Oil Condition Sensor	75 - 77
Features & Options	61	Overview	75
Laser Particle Counter	62 - 68		Oil Condition Sensor 76
 Portable	62 - 63	Interface-OCS-I-USB	76
LasPaC-II-P			
 Mobile	64 - 65		Oil Condition Display 77
LasPaC-II-M			
 Bottle Sampler Unit	66		OCS Starterkit 77
Bottle-Sampler-LasPaC-II			
 Accessories	67		
Technical Data (Overview)	68		
Particle Monitor	70 - 74		
 LPM-II	70		
 Interface-LPM-II-USB/ETH	71		
 Display-LPM-II-Remote	71		
 Flow Control Valve	72		
LPM-II-DAV			
 ATEX Device	73		
LPM-II- ... -CX			
 Oil Sampling Kit	74		
SFSK-1/-2			

C

Laser Particle Counter - Type LasPaC-II

C



Fluid analysis is a crucial component of any oil management program. Early detection of potential problems can prevent costly repairs and downtime. The LasPaC-II makes it possible to detect the ISO Cleanness levels of the hydraulic media.

Characteristics

The LasPaC-II devices feature a twin laser system and eight channels for different particle sizes in order to guarantee high accuracy and repeatability. These compact units are easy to handle for mobile and inline applications for systems with pressures up to 400 bar / 5801 PSI.

The LasPaC-II is available in three different versions:

LasPaC-II-P: Portable Laser Particle Counter

The LasPaC-II-P is a fully equipped portable laser particle counter.

The LasPaC-II-P features a complete QWERTY keyboard, an integrated thermal printer, an internal rechargeable battery and a large LCD display.

LasPaC-II-M: Mobile Laser Particle Counter

The LasPaC-II-M is a highly accurate laser particle counter. With a competitive price, the LasPaC-II-M is the best compromise between lower cost and brilliant accuracy/reliability.

All LasPaC-II devices have an internal data memory and are available within the accompanying Windows® based software package for reports and data downloads.

Overview

Options	LasPaC-II-P (Portable)	LasPaC-II-M (Mobile)	Bottle Sampler 110	Bottle Sampler 500	LPM-II
Laser Type	Twin-Laser	Twin-Laser	-	-	LED Laser
Analysis Range	8 channels (4,6,14,21,25,38,50,68 μm_d)	8 channels (4,6,14,21,25,38,50,68 μm_d)	-	-	8 channels (4,6,14,21,25,38,50,68 μm_d)
Power Supply	External	External	-	-	External
Battery Option	Internal	Internal (optional)	-	-	-
Display	Integrated (large)	Integrated (small)	-	-	Internal / External
Keyboard	Integrated	-	-	-	-
Printer	Integrated	-	-	-	-
Data Storage	Internal (for approximately 600 tests)	Internal (for approximately 600 tests)	-	-	Internal (for approximately 4000 tests)
PC Interface	RS-232	RS-232	-	-	RS485, RS232, Modbus, CAN Bus
Fluid Preparation	-	-	Integrated vacuum/pressure pump	Integrated vacuum/pressure pump	-
Maximal Bottle Size	-	-	110 ml	500 ml	-
Compatible with	Mineral oil and petroleum based fluids, Specific Water Glycol fluids or phosphate ester	Mineral oil and petroleum based fluids, Specific Water Glycol fluids or phosphate ester	Mineral oil and petroleum based fluids	Mineral oil, petroleum based fluids and Specific Water Glycol fluids or phosphate ester	Mineral oil and Specific Water Glycol fluids or phosphate ester



Laser Particle Counter - Type LasPaC-II

Features & Options: LasPaC-II (General)

Mobile - Compact and Convenient

The LasPaC-II-P (Portable), the LasPaC-II-M (Mobile) and all its accessories are supplied in a light-weight rugged industrial case.

This user-friendly portable case is waterproof and resistant against all common fluids.

Accuracy - Twin-laser, 100% Coverage

In all STAUFF laser particle counting devices, the fluid passes through the measuring cell and through a laser beam. The light from the laser is evaluated by a photo diode.

As the fluid passes through the laser beam the amount of light changes. These changes are directly proportional to size of the particles, and the total volume of particles. In many other particle counters only part of the measuring cell is lighted by the laser, thus only a part of the total amount of particles are registered, and the result is projected.

In contrast, the measuring cell of the LasPaC-II is completely examined, and all particles are registered. In addition to this, a second laser is used to analyze all particles sizes smaller than 6 $\mu\text{m}_{(0)}$.

Additionally, the integrated booster cylinder allows very precisely dosage of the test fluids. This ensures a very high accuracy with excellent repeatability.

Functional - Calibration to ISO 11 171

The LasPaC-II devices are calibrated with ISO Medium Test Dust (MTD) based on the ISO 11 171:1999 calibration standard.

STAUFF particle counters meet the new ISO 4406 cleanliness classification codes and provide results in the NAS 1638 and the SAE 4059 codes.

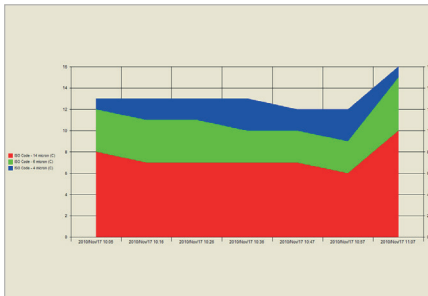

For any Type of Application - Large Pressure Range

A big advantage of the LasPaC-II devices is the wide pressure range: Low pressure measurements starting with 2 bar / 29 PSI and high pressure tests up to 400 bar / 5801 PSI result in reliable readings. Many other products available today require special add-on devices or pressure cartridges which need to be recharged for this.

The test hoses, which are provided with the device, allow an easy connection to common test couplings M16 x 2 (STAUFF TEST 20 or comparable).

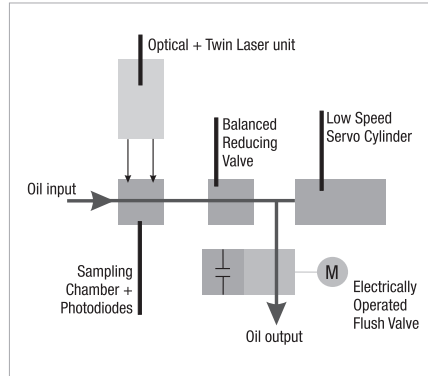

Global Use - Variable Voltage Supply

The external power supply unit provides most variable voltage ranges of 110 ... 240 V AC. European, UK and US plug adaptors ensure a worldwide applicability of the LasPaC-II.

Always Secure - External Alarms

The LasPaC-II-P devices offer the opportunity to define different alarm levels.

It is possible to configure two separate contamination alarm levels (e.g. clean alarm level and dirt alarm level). When set, an alarm indicator is given to external devices (e.g. indicator light, offline-filter) if the alarm level is reached.

Making the Connection -

Downloading with RS-232 Interface and USB Adaptor

The measured data can be downloaded onto any PC or laptop computer via the RS-232 interface or alternatively via a USB adaptor.

The LasPaC-II software supports an easy download for data processing of the recorded measurements.

Several diagrams are available and are automatically generated to offer a very clear arrangement of all data for analysis. Data can also be easily exported to Microsoft Excel®.

Always up-to-date - Integrated Clock

An integrated rechargeable battery-operated clock provides the exact date and time which are shown on every printout.

In addition, every download of measured data is marked with date and time as well. The precise time of measurement is documented on all printouts and for all data stored.

Adaptable - Software Updates

The RS-232 (or USB) interface ensures flexibility for future developments in terms of calibration, evaluation and output. Software updates can easily be installed onto the LasPaC-II devices.

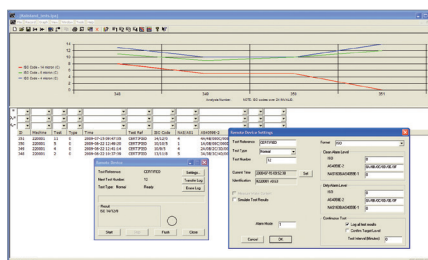

Cleanliness - High-Speed Flush Valve

To ensure an accurate measurement is taken, the sensor must be cleaned before each test.

The LasPaC-II achieves this by means of an electric operated flush valve. This valve can be opened on demand and between tests by simply depressing the flushing valve push button. The optimized design of the flush valve reduces the rinsing process to the minimum requirement, and ensures a quick restart of the next measurement.

For all Applications - High Compatibility

The LasPaC-II units are compatible with all Mineral Oil and Petroleum based fluids. Phosphate Ester (e.g. Skydrol®) and Water Glycol compatible devices are available upon request. Please contact STAUFF for details.

More Oil Information - The Moisture/ Temperature Sensor

The LasPaC-II also offers the option of adding an integral moisture / temperature sensor.

This sensor measures the moisture content of the test fluids (displayed as relative humidity in RH %) and also indicates the current fluid temperature (in °C).

Please note that the moisture/ temperature sensor is not compatible with Phosphate Ester (e.g. Skydrol®) and Water Glycol fluids.

For further information please see on page 67.

Optional - Bottle Sampling Unit

Highly aerated fluids may lead to inaccurate results.

Therefore a de-aeration facility has been incorporated into the optional bottle sampling units.

Both sizes (110 ml and 500 ml) of the bottle sampling unit are delivered with an external power supply, and allow the user to properly condition the sample fluid prior to any measurements taken. For further information please see on page 66.

Please note that the moisture/ temperature sensor as mentioned above does not work in conjunction with the bottle sampling unit.

Scope of Delivery

Each kit of a laser particle counter STAUFF LasPaC-II includes:

- 1x Laser particle counter STAUFF LasPaC-II
- 1x LasPaC-II-M / LasPaC-II-P: Waste hose 2 m / 3.65 ft
- 1x Pressure hose: 1,5 m / 2.67 ft
- 1x Waste bottle
- 1x External power supply including cable with European, UK and USA plug adaptors
- 1x RS-232 connecting cable, 1 m / 1.78 ft including RS-232 to USB converter
- 1x Software CD "LasPaC-II View"
- 1x User guide LasPaC-II
- 1x User guide LasPaC-II View
- 3x Thermal printer paper (only with LasPaC-II-P)



Laser Particle Counter ▪ Type LasPaC-II-P (Portable)



Light-Weight Rugged Industrial Case



Integrated Printer

Product Description

The LasPaC-II-P (Portable) is the most complete way to measure the contamination level of your system. With the LasPaC-II-P you have the ability to measure, analyze and document your results immediately without the need of any additional equipment.

Features

Quick Results - Fast Results and Easy Operation

The integrated complete QWERTY keyboard, a large LCD display and intuitive handling all lead to the easy and quick operation of the LasPaC-II Portable. The optimized flushing process of the LasPaC-II-P is quick and effective, and allows for continuously accurate measurements.

Black and White - Integrated Printer

The integrated printer in the LasPaC-II-P supports print-outs in the field, thus providing immediate documentation. Every printout confirms date and time of your measurement.

Independent Use - Rechargeable Battery Mode

The integrated rechargeable battery of the LasPaC-II-P allows the use of on site measurements, even in the event where access of an external power source is not available. The measurement data is stored in the internal memory of the unit and can be transferred to a computer when required.

Once charged the LasPaC-II-P can run approximately 100 tests before recharging is needed again.

Options

- **Moisture / Temperature Sensor**
This sensor measures the moisture content of the test fluids (displayed as relative humidity in RH %) and also indicates the current fluid temperature (in °C). For further information please see on page 67.
- **Phosphate Ester (e.g. Skydrol®) or specific Water Glycol fluids units on request**

Order Codes

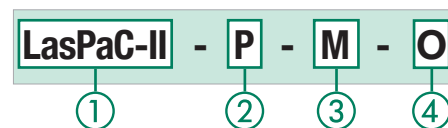

① Series and Types

Laser Particle Counter	LasPaC-II
------------------------	-----------

② Version

Portable	P
----------	---

③ Fluid Compatibility

Mineral Oil, Petroleum based fluids (standard option)	M
Phosphate Ester (e.g. Skydrol®)	E
Specific Water Glycol fluids	G

④ Moisture/ Temperature Sensor

Without moisture/ temperature sensor	O
With moisture/ temperature sensor	W

Please note: The moisture/ temperature sensor is not suitable for Phosphate Ester (e.g. Skydrol®) and Water Glycol fluids.



Laser Particle Counter ■ Type LasPaC-II-P (Portable)



Highspeed Flush Valve



Computer Interfaces of the LasPaC-II-P



Easy Connection to common Test Couplings

Technical Data

Dimensions and Weight

- L/W/H: 551 x 358 x 226 mm / 21.69 x 14.09 x 8.90 in
- Weight: 13 kg / 28.66 lbs

Keyboard / Printer

- Keyboard: QWERTY keyboard
- Printer: Integrated thermal printer (384 dots per line)

Power Supply

- Voltage range: 110 ... 240 V AC / 12 ... 24 V DC
- European, UK and US power plug adaptors included
- Number of tests before recharging is required: 100

Calibration

- Calibration: ISO Medium Test Dust (MTD) according to ISO 11 171:1999
- Analysis range: ISO 8-24, ISO 4406 Code, NAS 1638 Code 2-12, SAE AS 4059 Code 2-12

Pressure / Viscosity

- Pressure range: 2 ... 400 bar / 29 ... 5801 PSI
- Viscosity range: 1 ... 400 cSt

Laser Sensors

- High accuracy laser: 4 ... 6 $\mu\text{m}_{(e)}$
- Standard accuracy laser: 6 ... 68 $\mu\text{m}_{(e)}$
- Measured channels: 4, 6, 14, 21, 25, 38, 50, 68 $\mu\text{m}_{(e)}$
- The orifice of the sensor has a cross section of 0,9 x 0,9 mm / .04 x .04 in
- The maximum concentration is ISO 4406 Code 24 (160.000 p/ml)

Accessories

- Bottle Sampling Unit 110 ml (for Mineral Oil and Petroleum based fluids)
- Bottle Sampling Unit 500 ml (for Mineral Oil and Petroleum based fluids)
- Bottle Sampling Unit 500 ml (Version E) (for Phosphate Ester (e.g. Skydrol®) available on request) For further information please see on page 66.
- Screen filter: 500 μm (see on page 67)

Hose Connections

- Test coupling STAUFF Test 20 or comparable (M16 x 2)

Sample Volume

- 8 ml (short)
- 15 ml (normal)
- 30 ml (dynamic)
- 24 ml (bottle sampler)
- 15 ml (continuous)

Permissible Temperature

- Operating: +5 °C ... +80 °C / +41 °F ... +176 °F

Data Output

- Cumulative particle counts, as well as cleanliness classes according to ISO 4406 (1999) / SAE AS 4059 Rev.D (2001) and ISO 4406 (1191) / NAS 1638 (1964)

Max. Concentration

- ISO 24

Accumulator

- Internal rechargeable battery

Data Storage

- 600 tests

Fluid Compatibility

- Mineral Oil, Petroleum based fluids
- Phosphate Ester and Water Glycol compatible devices on request

Computer Interface

- RS-232 communication port as standard
- USB adaptors included

External Alarm

- External alarm socket with switching outputs max. 24 V DC/AC, 1 A

Software

- Downloading and storage of the data with included "LasPaC-II View" software. Further processing with Microsoft Excel® possible.



Laser Particle Counter ▪ Type LasPaC-II-M (Mobile)



LasPaC-II-M with integrated battery (standard option)



LasPaC-II-M also available without integrated battery

Product Description

The LasPaC-II-M is a highly accurate laser particle counter. With a competitive price, the LasPaC-II-M is the best compromise between lower cost and brilliant accuracy/reliability.

Features

Versatile - Lightweight and Convenient

The LasPaC-II-M (Mobile) is designed for applications where it is necessary to have a small, light and robust service unit.

Low Cost - Same Functions for a Budget Price

Without losing the quality in measurement accuracy, reliability and repeatability the LasPaC-II-M is a cost effective alternative to the fully equipped LasPaC-II-P.

Options

- **Moisture / Temperature Sensor**
This sensor measures the moisture content of the test fluids (displayed as relative humidity in RH %) and also indicates the current fluid temperature (in °C).
For further information please see on page 67.
- **Phosphate Ester (e.g. Skydrol®) or specific Water Glycol fluids units on request**
- LasPaC-II-M also available without integrated battery

Order Codes

LasPaC-II - M - M - O - B				
①	②	③	④	⑤
① Type and Series		Laser Particle Counter		LasPaC-II
② Version		Mobile		M
③ Fluid Compatibility		Mineral Oil, Petroleum based fluids (standard option)		M
		Phosphate Ester (e.g. Skydrol®)		E
		Specific Water Glycol fluids		G
④ Moisture/ Temperature Sensor		Without moisture/ temperature sensor		O
		With moisture/ temperature sensor		W
Please note: The moisture/ temperature sensor is not suitable for Phosphate Ester (e.g. Skydrol®) and Water Glycol fluids.				
⑤ Battery		With internal rechargeable battery (standard option)		B
		Without internal rechargeable battery		O



Laser Particle Counter ■ Type LasPaC-II-M (Mobile)



LasPaC-II-M with small Bottle Sampler



Display and Buttons

Technical Data

Dimensions and Weight

- L/W/H: 340 x 295 x 152 mm /
13.40 x 11.61 x 5.98 in
- Weight: 4,75 kg / 10.47 lbs

Power Supply

- Voltage range: 110 ... 240 V AC
12 ... 24 V DC
- European, UK and US power plug adaptors included
- Number of tests before recharging is required: 60

Calibration

- Calibration: ISO Medium Test Dust (MTD)
according to ISO 11 171:1999
- Analysis range: ISO 8-24, ISO 4406 Code,
NAS 1638 Code 2-12,
SAE AS 4059 Code 2-12

Pressure / Viscosity

- Pressure range: 2 ... 400 bar / 29 ... 5801 PSI
- Viscosity range: 1 ... 400 cSt

Laser Sensors

- High accuracy laser: 4 ... 6 $\mu\text{m}^{(c)}$
- Standard accuracy laser: 6 ... 68 $\mu\text{m}^{(c)}$
- Measured channels: 4, 6, 14, 21, 25, 38, 50, 68 $\mu\text{m}^{(c)}$
- The orifice of the sensor has a cross section of
0,9 x 0,9 mm / .04 x .04 in
- The maximum concentration is ISO 4406 Code 24
(160.000 p/ml)

Accessories

- Bottle Sampling Unit 110 ml
(for Mineral Oil and Petroleum based fluids)
- Bottle Sampling Unit 500 ml
(for Mineral Oil and Petroleum based fluids)
- Bottle Sampling Unit 500 ml (Version E)
(for Phosphate Ester (e.g. Skydrol®) available on request)
For further information please see on page 66.
- Screen filter: 500 μm (see on page 67)

Hose Connections

- Test coupling STAUFF Test 20 or comparable (M16 x 2)

Sample Volume

- 8 ml (short)
- 15 ml (normal)
- 30 ml (dynamic)
- 24 ml (bottle sampler)
- 15 ml (continuous)

Permissible Temperature

- Operating: +5 °C ... +80 °C / +41 °F ... +176 °F

Data Output

- Cumulative particle counts, as well as cleanliness classes
according to ISO 4406 (1999) / SAE AS 4059 Rev.D (2001)
and ISO 4406 (1191) / NAS 1638 (1964)

Max. Concentration

- ISO 24

Data Storage

- 600 tests

Fluid Compatibility

- Mineral Oil, Petroleum based fluids
- Phosphate Ester and Water Glycol compatible devices on
request

Computer Interface

- RS-232 communication port as standard
- USB adaptors included

Software

- Downloading and storage of the data with included
"LasPaC-II View" software. Further processing with
Microsoft Excel® possible.

Internal Rechargeable Battery

- Standard option with internal rechargeable battery



Bottle Sampling Unit ▪ Typ Bottle-Sampler-LasPaC-II



Bottle Sampling Unit 110 ml and Accessories



Bottle Sampling Unit 110 ml



Bottle Sampling Unit 500 ml

Product Description

Analysis Everywhere - Bottle Sampling Unit

If a direct particle count on your system is not possible, the LasPaC-II bottle sampler units allow you to take measurement samples for analysis at a later time.

Conditioning - The De-aeration Facility

A highly aerated fluid may lead to inaccurate results; therefore a de-aeration process has been incorporated into the bottle sampling units.

By evacuating the air from the sampling chamber, aeration within the fluid is removed, and the fluid is properly conditioned prior to sampling.

Your Choice - 110 ml or 500 ml Size

STAUFF offers two sizes of bottle sampling units for the LasPaC-II devices: the 110 ml and the 500 ml units.

The 110 ml unit is supplied in an extra case including various accessories such as power supply, sampling hoses, pressure hoses, bottles (sample and waste) and adaptors. It is designed for mobile applications and is only compatible with Mineral Oil and Petroleum based fluids.

The standard version of the 500 ml unit is compatible with Mineral Oil and Petroleum based fluids; a Phosphate Ester (e.g. Skydrol®) compatible version of the 500 ml unit is available on request. Please contact STAUFF for details.

The 500 ml bottle sampling unit is delivered with the required power supply.

Please note that the moisture / temperature sensor does not work in combination with bottle sampler devices.

Order Codes



① **Bottle Sampling Unit**

Bottle Sampling Unit **Bottle-Sampler**

② **Type and Series**

Laser Particle Counter **LasPaC-II**

③ **Unit**

110 ml Bottle Sampling Unit suitable for Mineral Oil and Petroleum based fluids only	110-M
500 ml Bottle Sampling Unit suitable for Mineral Oil and Specific Water Glycol fluids, Petroleum based fluids only	500-M/G
500 ml Bottle Sampling Unit suitable Phosphate Ester (e.g. Skydrol®)	500-E



Moisture / Temperature Sensor

Product Description

More Oil Analysis - Oil Saturation and Temperature

In Mineral Oils and non-aqueous fire resistant fluids, water is undesirable. Once the water exceeds a saturation level (about 500 ppm for Mineral Oils) the fluid starts to appear hazy. Above this level there is a danger of free water accumulating in the system. This can lead to corrosion and accelerated wear.

As an option, all LasPaC-II devices provide accurate and repeatable measurement of the saturation level of water in oil with the moisture / temperature sensor. The sensor is located internally in a specially designed housing and is positioned in the low pressure constant flow line.

Additional Information - Oil Temperature Readings

Beside the saturation level the optional moisture / temperature sensor of the LasPaC-II units has the ability to measure the fluid temperature. This allows to provide a reference temperature for the RH (relative humidity / % saturation of water in oil) readings.

Both results, RH % and °C, are displayed on the main / test progress screen and on the printed analysis.

Please note: Due to the temperature gradient existing between the system tapping point and the RH / temperature module, the temperature reading can be 5° to 10° less than the actual system temperature, depending on operating conditions. The moisture / temperature sensor is not suitable for bottle sampling.

Saturation Levels

Since the effects of free (also emulsified) water are more harmful than those of dissolved water, water levels should remain always well below the saturation point.

However, even water in solution can cause damage, and therefore every reasonable effort should be made to keep saturation levels as low as possible.

There is no such thing as too little water. As a guideline, we recommend maintaining saturation levels below 50 % in all equipment.

Different oils have different saturation levels, and % saturation is the best and most practical measurement.

These results can be converted to ppm (parts per million), if the oil type saturation / temperature characteristic is known.

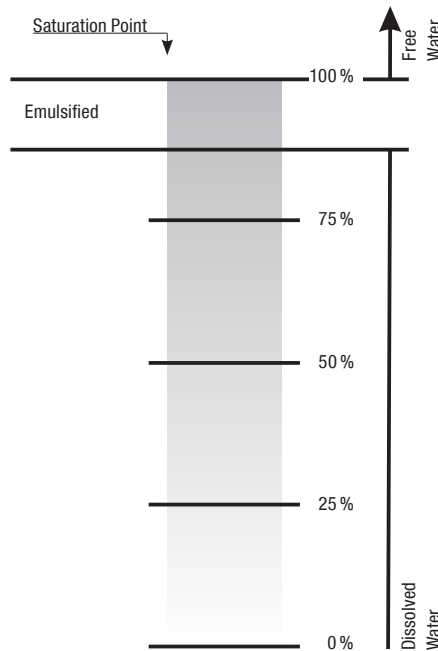

Laser Particle Counter - Accessories



Order Codes

Accessories / Spare Parts

①

① Type of Accessories / Spare Parts

Waste hose 2 m / 6.56 ft	Hose-LasPaC-II-Waste-2m
Pressure hose 1,5 m / 4.92 ft	SMS-20-1500-A-W3
110 ml certified clean bottle (5 pieces)	Set-Bottle-LasPaC-II-110-C
250 ml certified clean bottle (5 pieces)	Set-Bottle-LasPaC-II-250-C
110 ml glass sample bottle (5 pieces)	Set-Bottle-LasPaC-II-110
250 ml glass sample bottle (5 pieces)	Set-Bottle-LasPaC-II-250
500 ml glass sample bottle (5 pieces)	Set-Bottle-LasPaC-II-500
Printer paper LasPaC-II-P (5 pieces)	Set-Paper-LasPaC-II-Printer
RS 232 to USB converter	Adaptor-PPC-04/12-RS232-to-USB-CAB
Screen filter	Screen-Filter-LasPaC-II



Product Description: Screen Filter

An optional Screen Filter is available for heavily contaminated systems. The filter device is assembled directly to the supply line and allows particle counts in ambient conditions where normally the contamination is too high for a reliable test.

The Stainless Steel Filter has a mesh of 500 µm and is cleanable.



Laser Particle Counter ■ Technical Data

			
Type	LasPaC-II-P (Portable)	LasPaC-II-M (Mobile)	LPM-II
Dimensions (mm/in) (W x D x H)	551 x 358 x 226 21.69 x 14.09 x 8.90	340 x 295 x 152 13.40 x 11.61 x 5.98	141 x 116 x 63,5 5.55 x 4.57 x 2.5
Weight (kg/lbs)	13 28.66	4,75 10.47	1,15 2.53
Keyboard	QWERTY keyboard integrated	-	5 Button Display Settings
Printer	Thermal printer integrated (384 dots per line)	-	-
Viscosity Range	1 ... 400 cSt	1 ... 400 cSt	<= 1000 cSt
Calibration	MTD, ISO 11 171:1999	MTD, ISO 11 171:1999	MTD, ISO 11171:1999
Analysis Range	ISO 8-24, ISO 4406 Code, NAS 1638 Code 2-12, SAE AS 4059 Code 2-12	ISO 8-24, ISO 4406 Code, NAS 1638 Code 2-12, SAE AS 4059 Code 2-12	ISO 8-24, ISO 4406 Code, NAS 1638 Code 2-12, SAE AS 4059 Code 2-12
Sensitivity	4, 6, 14, 21, 25, 38, 50, 68 $\mu\text{m}_{(c)}$	4, 6, 14, 21, 25, 38, 50, 68 $\mu\text{m}_{(c)}$	4, 6, 14, 21, 25, 38, 50, 68 $\mu\text{m}_{(c)}$
Sample Volume	8 ml (short) 15 ml (normal) 30 ml (dynamic) 24 ml (bottle sampler) 15 ml (continuous)	8 ml (short) 15 ml (normal) 30 ml (dynamic) 24 ml (bottle sampler) 15 ml (continuous)	Adjustable by user
Pressure Range (bar/psi)	2 ... 400 29 ... 5801	2 ... 400 29 ... 5801	Please refer differential pressure diagram
Operating Temperature (°C/°F)	+5 ... +80 +41 ... +176	+5 ... +80 +41 ... +176	-25 ... +80 -13 ... +176
Max. Concentration	ISO 24	ISO 24	ISO 24
Power Supply	110 ... 240 V AC 12 ... 24 V DC	110 ... 240 V AC 12 ... 24 V DC	110 ... 240 V AC 9 ... 36 V DC, <2,2W
Battery	Internal rechargeable battery	Internal rechargeable battery	-
Data Storage	600 tests	600 tests	4000 tests
Fluid Compatibility	Mineral Oil / Petroleum based fluids; Phosphate Ester and water glycol compatible devices on request	Mineral Oil / Petroleum based fluids; Phosphate Ester and Water Glycol compatible devices on request	Mineral Oil / Petroleum based fluids; Phosphate Ester and Water Glycol compatible devices on request
PC Interface	RS-232	RS-232	RS-232
External Alarm	External alarm socket	-	External Alarm
Hose Connections	Test coupling STAUFF Test 20 or comparable (M16 x 2)	Test coupling STAUFF Test 20 or comparable (M16 x 2)	Test coupling STAUFF Test 20 or comparable (M16 x 2)
Accessories	Moisture/temperature sensor Bottle sampling unit (110 ml / 500 ml) Screen filter (500 μm)	Moisture/temperature sensor Bottle sampling unit (110 ml / 500 ml) Screen filter (500 μm)	Remote Display Interface Module Flow Control Valve



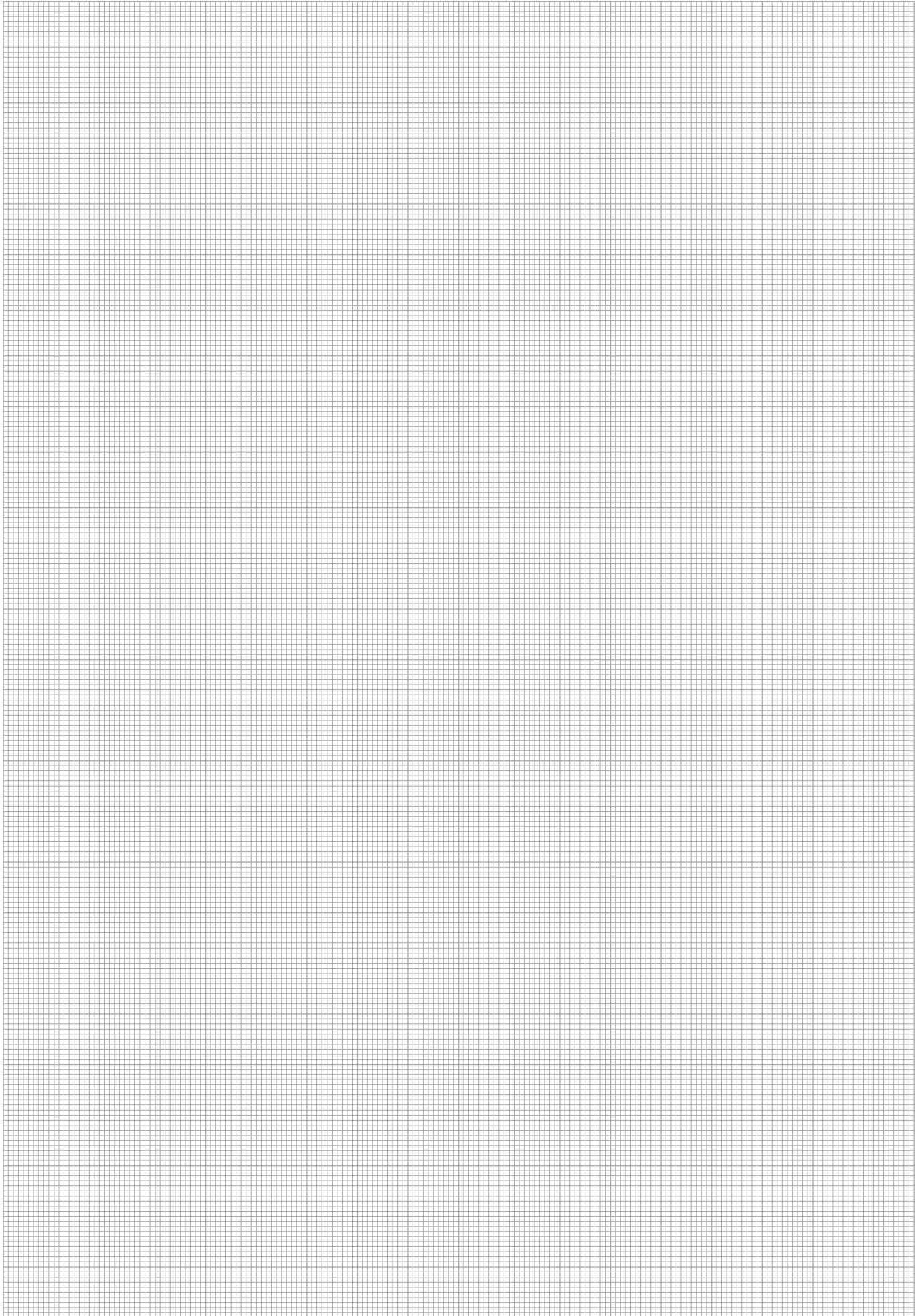

Particle Monitor - LPM-II

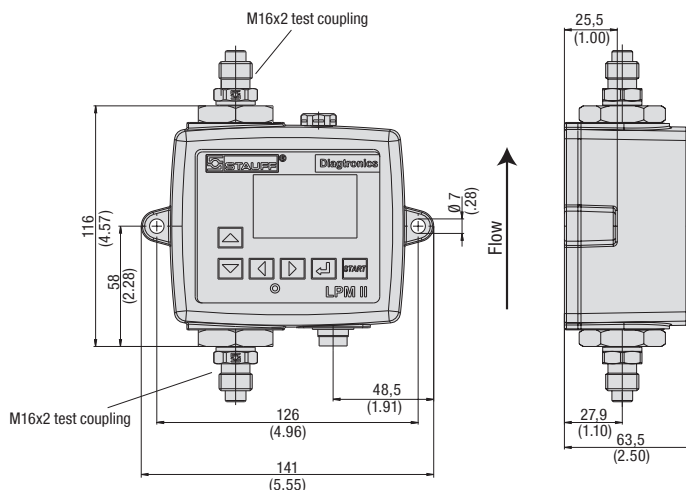

Product Description

The LPM-II Particle Monitor determines the contamination level of the measured fluid on eight size channels and offers precise and complete determination of particle sizes in accordance with international standards.

The LPM-II is an automatic, optical particle counter with high-performance LEDs that work on the light obscuration principle. STAUFF recommends recalibrating the measuring equipment at regular intervals.

Options

- Moisture sensor / temperature sensor: RH in % (relative humidity) and temperatures in °C
- Phosphate Ester- (e.g. Skydrol®) and Water Glycol-compatible devices are available on request

Technical Data

Channels

- >4, 6, 14, 21, 25, 38, 50, 70 µm(c) according to ISO 4406:1999

Measuring Range / Purity Classes

- ISO 4406:1999 Code 0 to 25, NAS 1638 Class 00 to 12, AS4059 Rev. E. Tables 1 and 2 Sizes A-F: Classes 000 to 12, ISO 11218 Classes 00 to 12 (lower codes or classes are test time-dependent)

Precision

- ±1/2 Code for 4, 6, 14 µm(c)
- ±1 Code for larger particles

Calibration

- Each device is individually calibrated using ISO Medium Test Dust (MTD) in accordance with ISO 11171 (1999);

Flow

- 20 ... 400 ml/min / 0.005 ... 0.11 US GPM

Viscosity Range

- ≤ 1000 mm²/s

Medium Temperature

- 25 °C ... +80 °C / -13 °F ... +176 °F *pressure-dependent

Ambient Temperature

- LMP II-O: -25 °C ... +80 °C / -13 °F ... +176 °F
- LMP II-D: -25 °C ... +55 °C / -13 °F ... +131 °F

Weight

- 1.15 kg / 2.53 lbs

Order Codes

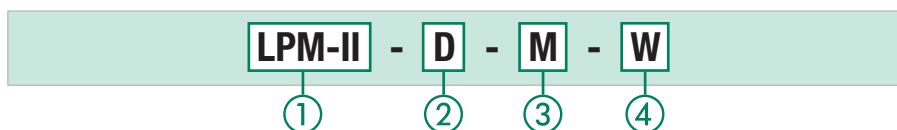

① Series and Type

Particle Monitor **LPM-II**
(Incl. LPM-II-CAB-P-FL-3 connecting cable)

② Version

With display and keypad **D**
Without display and keypad **O**

③ Fluid Compatibility

Fluids based on Mineral Oil and Petroleum (standard) **M**
Phosphate Ester (e.g. Skydrol®) **E**
Specific Water Glycols **G**

Note: If you have any queries on fluid compatibility, please contact STAUFF.

④ Moisture Sensor / Temperature Sensor

Without moisture sensor / temperature sensor **O**
With moisture sensor / temperature sensor **W**

Note: In the case applications with extreme pressure peaks, please contact STAUFF.

Note: Versions "E" and "G" can only be supplied without moisture sensor / temperature sensor

Note: You need an interface module with either a USB or an Ethernet interface for exporting and programming.

Fluid Compatibility

- M:** suitable for Synthetic and Mineral Oil based fluids, Diesel and Petroleum
- G:** Austenitic Stainless Steel, FKM (Viton®): suitable for offshore and aqueous fluids
- E:** Austenitic Stainless Steel, Perfluorinated Rubber (FFKM): suitable for Phosphate Ester and aggressive media

Max. Permissible Operating Pressure

- 400 bar / 5801 PSI static *temperature-dependent (Note: In systems with extreme pressure peaks, please contact STAUFF)

Test Duration

- Settable between 10 ... 3600 sec., set ex-works to 120 sec.
- As standard with start delay and freely programmable test intervals

Moisture Sensor / Temperature Sensor

- % RH (relative humidity) ±3 %
- ±3 °C / ±32 °F

Volumetric Flow Measurement

- As display only

Hose Connections

- Test coupling STAUFF Test 20 or comparable (M16 x 2)

Data Storage

- Max. 4000 measuring results

Interfaces

- RS485, RS232, Modbus, CAN Bus

International Protection Rating

- IP 65: Dust-proof and protected from spray
- Impact resistance rating IK04

Power Supply / Power

- 9 ... 36 V DC, < 2.2 W (connecting cable with flying leads is included)

Current Consumption

- 12 V: 70 mA (LPM-II-O), 150 mA (LPM-II-D)
- 24 V: 40 mA (LPM-II-O), 80 mA (LPM-II-D)
- 36 V: 30 mA (LPM-II-O), 60 mA (LPM-II-D)

Housing Surface Treatment

- Painted, Polyurethane based paint, according to BSX34 colour BS381-638 (dark grey)
- Tested according to: BS2X34A and BS2X34B, MMO114 and SP-J-513-083 Part II. Cl. A
- The unit meets: MIL-PRF-85285

Wetted parts

- M:** C46400 Cu Alloy, 316 Stainless Steel, FKM (Viton®), FR4, Sapphire
- G:** 316 Stainless Steel, FKM (Viton®), Sapphire
- E:** 316 Stainless Steel, Perfluorinated Rubber (FFKM), Sapphire, EPDM



Interface Module with USB or Ethernet Interface ▪ INTERFACE -LPM-II-USB/ETH

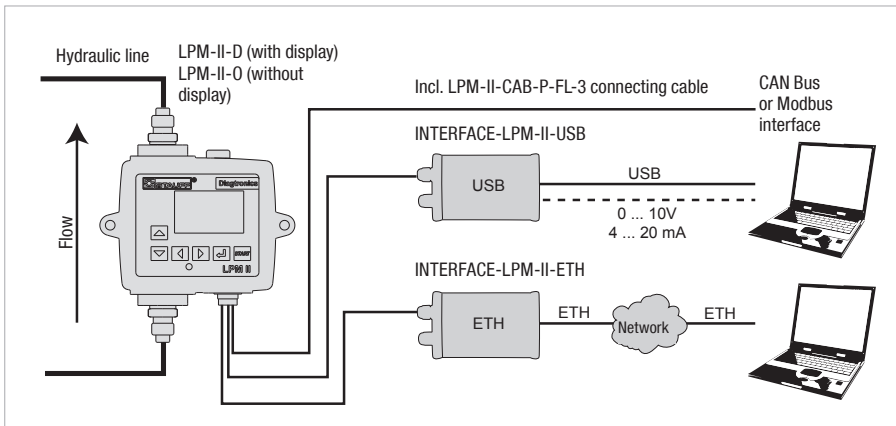

Connection diagram: PC connection of the LPM-II Particle Monitor

Order Code

INTERFACE-LPM-II-USB



① Series and Type

- Interface module with USB interface **INTERFACE-LPM-II-USB**
- Interface module with USB interface **INTERFACE-LPM-II-USB-010V**
- Interface module with USB interface **INTERFACE-LPM-II-USB-420A**

Scope of supply:

- Power supply unit
- Interface module with USB interface
- Connecting cable (3 m / 9.84 ft)
- USB cable

Order Code

INTERFACE-LPM-II-ETH



① Series and Type

- Interface module with Ethernet interface **INTERFACE-LPM-II-ETH**

Scope of supply:

- Power supply unit
 - Interface module with Ethernet interface
 - Connecting cable (3 m / 9.84 ft)
- Note: An Ethernet cable is not supplied.

Product Description

The LPM-II is connected to an EDP system or a laptop/PC using an interface module with a USB or an Ethernet interface.

Either interface module is connected to the LPM-II using a connecting cable (3 m / 9.84 ft). With the power supply unit connected, the LPM-II is supplied with current via the connecting cable.

The interface modules allow you to evaluate the measured data and to carry out programming using the supplied software.

In USB operation, the LPM-II can be supplied with current via the USB cable too.

The USB interface is optionally also available with additional 0-10 V or 4-20 mA outputs. The 0-10 V interface provides six ISO channels, the relative humidity and the temperature on eight voltage outputs. The 4-20 mA version, on the other hand, supplies e.g. the NAS code and the relative humidity on two outputs.

Remote Display Unit ▪ DISPLAY-LPM-II-REMOTE

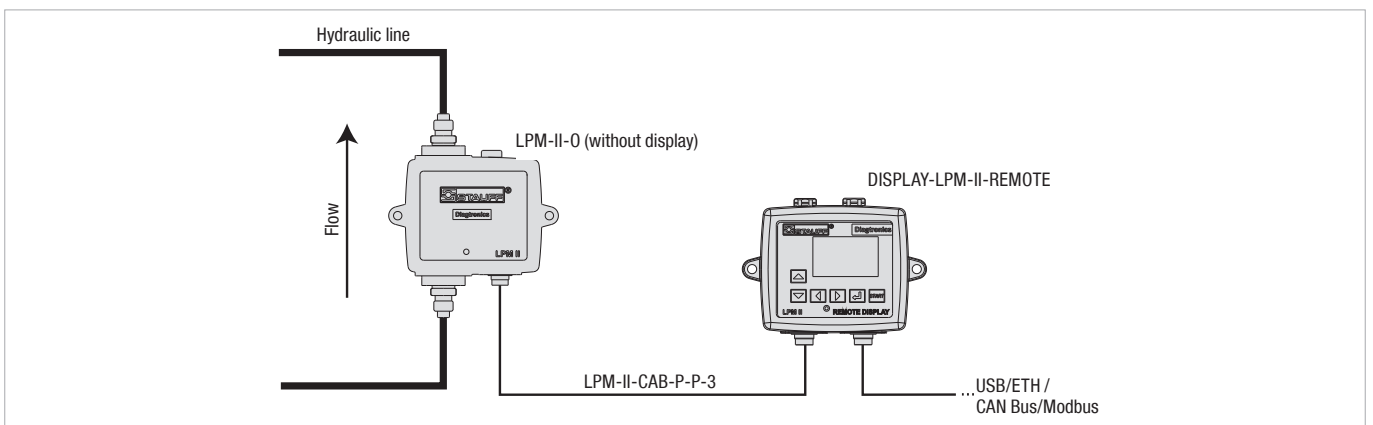

Connection diagram: Remote display

Order Code

DISPLAY-LPM-II-REMOTE



① Series and Type

- DISPLAY-LPM-II-REMOTE**

Scope of supply:

- Remote Display
- LPM-II-CAB-P-P-3 connecting cable

Product Description

In the case of applications outside the operator's field of view or in locations that are difficult to access, it is possible to display via a remote display the values that the LPM-II measured.



Flow Control Valve - LPM-II-DAV

C

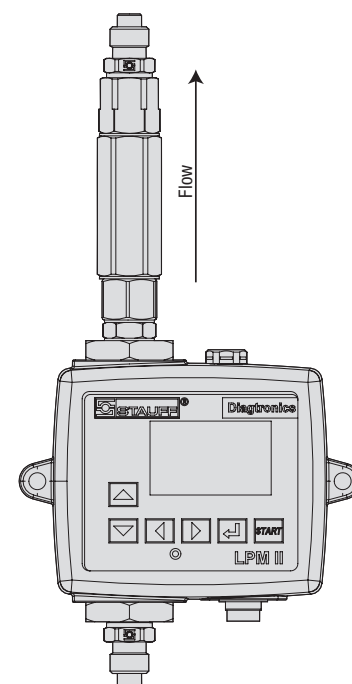
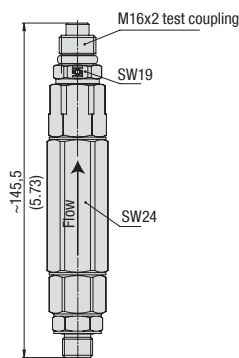

LPM-II with flow control valve LPM-II-DAV

Product Description

In systems in which the volumetric flow or the pressure is too high, the optimum flow is achieved with the use of a flow control valve.

It can process pressures from 4 bar ... 400 bar / 58 PSI ... 5801 PSI.

The LPM-II-DAV, flow control valve is connected to the hydraulic outlet of the LPM-II via the connection fittings.

Max. Permissible Operating Pressure

- 400 bar / 5801 PSI

(Note: Note that a minimum operating pressure of 4 bar / 58 PSI must be maintained for the proper function of the flow control valve.)

Order Code

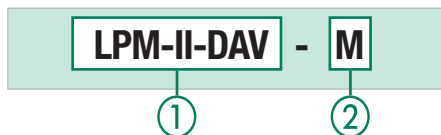

① Series and Type

Flow Control Valve **LPM-II-DAV**

② Fluid Compatibility

Fluids based on Mineral Oil and Petroleum (standard)	M
Phosphate Ester (e.g. Skydrol®)	E
Specific Water Glycols	G

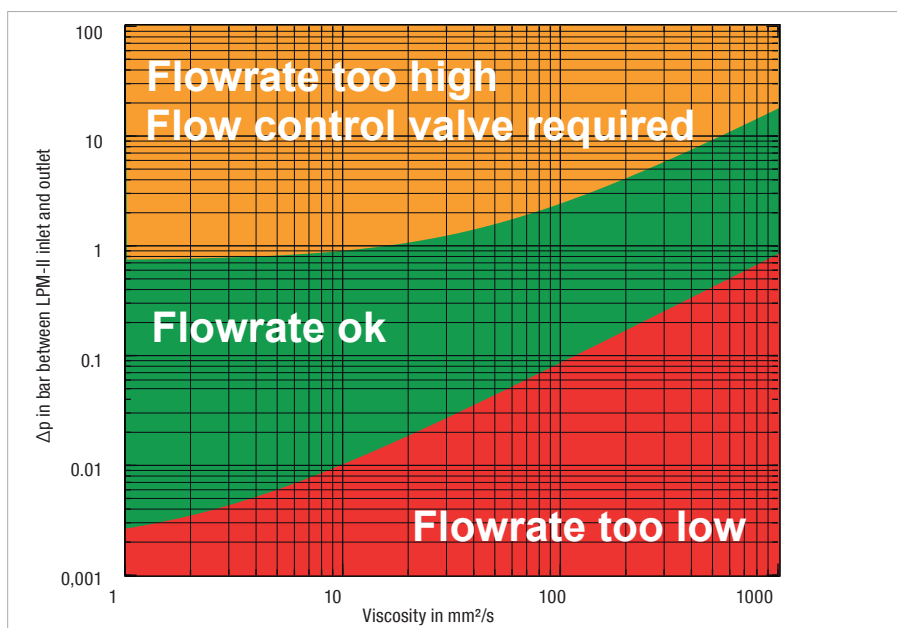

Particle Monitor ■ LPM-II-...-CX

Wiring Diagram

Note: Please note that an ATEX approved connecting cable is not included in the scope of delivery of LPM-II-0-...-CX. A corresponding ATEX plug is included.

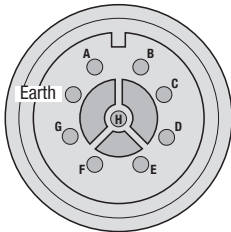

View when looking at supplied male connector

- A Data-
- B Data+
- C Power 0V
- D Power +9V-36V DC
- E Output 1
- F Output 2
- G Common
- H Start

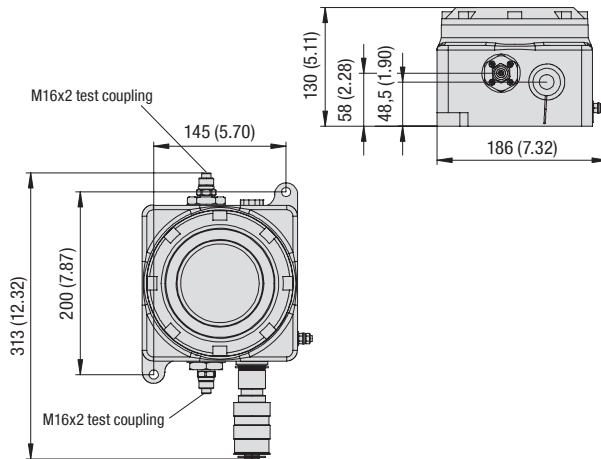

Order Codes

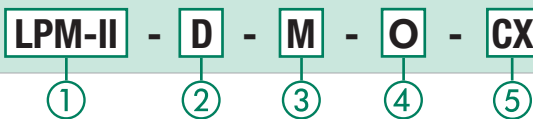

① Series and Type

Particle Monitor **LPM-II**

② Version

With display **D**

③ Fluid Compatibility

Fluids based on Mineral Oil and Petroleum (standard) **M**
 Phosphate Ester (e.g. Skydrol®) **E**
 Specific Water Glycols **G**

Note: If you have any queries on fluid compatibility, please contact STAUFF.

④ Moisture Sensor / Temperature Sensor

Without moisture sensor / temperature sensor **O**
 With moisture sensor / temperature sensor **W**

⑤ Version according to ATEX 94/9/EG

ATEX certification (Zone 2 / Cat. 3G) **CX**

Note: Versions „E“ and „G“ can not be supplied with moisture sensor / temperature sensor.

Note: You need an interface module with either USB or an ethernet interface for exporting and programming. The USB interface is not ATEX rated.

Product Description

The ATEX version of the Particle Monitor LPM-II is approved for use in hazardous areas (zone 2 / category 3G). The device thus meets the conditions to be used in e.g. oil and gas industry or chemical and process industry.

Product Features

- Determines contamination level of measured fluids in 8 size particle channels
- Precise and complete determination of particle sizes in accordance with international standards
- Integrated data storage for up to 4000 measuring results
- Integrated Modbus and CAN Bus interfaces can be used to connect the device to existing machine control, and data acquisition systems
- Option to specify different alarm thresholds
- Software on CD (included)
- ATEX compliant (Zone 2 / Category 3G)

Technical Data

Channels

- >4, 6, 14, 21, 25, 38, 50, 70 µm(c) acc. to ISO 4406:1999

Measuring Range / Purity Classes

- ISO 4406:1999 Code 0 to 25, NAS 1638 classes 00 to 12, AS4059 Rev. E. tables 1 and 2 sizes A-F: classes 000 to 12, ISO 11218 classes 00 to 12 (lower codes or classes are test time-dependent)

Accuracy

- ±1/2 code for 4, 6, 14 µm(c)
- ±1 code for larger particles

Calibration

- Each device is individually calibrated using ISO Medium Test Dust (MTD) in accordance with ISO 11171 (1999)

Flow

- 20 ... 400 ml/min / .00511 US GPM

Viscosity Range

- ≤ 1000 mm²/s

Temperature Range

- Media: -25 °C ... + 80 °C / -13 °F ... +176 °F
- Ambient: -5 °C ... +80 °C / +23 °F ... +176 °F

Weight

- 5,5 kg / 12.16 lbs

Power Supply

- 9 ... 36 V DC

Fluid Compatibility

- M: suitable for Synthetic and Mineral Oil based fluids, Diesel and Petroleum
- G: Austenitic Stainless Steel, FKM (Viton®): suitable for offshore and aqueous fluids
- E: Austenitic Stainless Steel, Perfluorinated Rubber (FFKM): suitable for Phosphate Ester and aggressive media

Max. Permissible Operating Pressure

- 400 bar / 5801 PSI (Note: In systems with extreme pressure peaks, please contact STAUFF)

Test Duration

- Settable between 10 ... 3600 sec., set ex-works to 120 sec.
- As standard with start delay and freely programmable test intervals

Moisture Sensor / Temperature Sensor

- % RH (relative humidity) ±3 %
- ±3 °C / ±32 °F

Volumetric Flow Measurement

- As display only

Hose Connections

- Test coupling STAUFF Test 20 or comparable (M16 x 2)

Data Storage

- Max. 4000 measuring results

Interfaces

- RS485, RS232, Modbus, CAN Bus

Current Consumption

- 12 V: 70 mA
- 24 V: 40 mA
- 36 V: 30 mA

Power

- <2,2 W

Housing Surface Treatment

- Polyester vinyl paint (light grey)
- Cast
- Stainless Steel
- Material spec.: ANC ABF/C

Wetted Parts

- M: C46400 Cu Alloy, 316 Stainless Steel, FKM (Viton®), FR4, Sapphire
- G: 316 Stainless Steel, FKM (Viton®), Sapphire
- E: 316 Stainless Steel, Perfluorinated Rubber (FFKM), Sapphire, EPDM

ATEX Directive 94/9/EG

Harmonises legal provisions of memberstates for devices and protection systems for designated use in potentially explosive areas.

ATEX Classification

- CE II 3G Ex nR IIB T6 X

ATEX Rating

- Zone 2 / Cat. 3G



Oil Sampling Kit ■ Type SFSK-1 / -2



Product Description

Fluid analysis is a crucial component of any oil management program. Early detection of potential problems can prevent costly repairs and downtime. STAUFF SFSK oil analysis kits provide the tools to take a sample from a STAUFF test coupling or directly from a reservoir or sump.

For this the supplied hose is directly connected to the test coupling with an adaptor and the fluid is filled into the supplied vials.

But there is also the possibility to draw up the sample directly from a tank with the hand pump and fill it into the vial.

This sample set is available in two versions with BSP and NPT test couplings.

Scope of Delivery

- Contains vacuum pump for drawing samples of oil equipment
- 1 m / 3.28 ft hose for insertion into tank
- Two sample bottles
- STAUFF test points and adaptor allows oil sample to be taken from STAUFF Test 20 test points

Components

SFSK-1

- 1x Fluid Sample Pump FSP-38
- 1x Hose adaptor SHA-20-5.5mm
- 1 m / 3.28 ft Push on 1/4" hose
- 1x SMK-20-1/4NPT-V-D-W3
- 1x SMK-20-7/16UNF-V-E-W3
- Sample bottles

SFSK-2

- 1x Fluid Sample Pump FSP-38
- 1x Hose adaptor SHA-20-5.5mm
- 1 m / 3.28 ft Push on 1/4" hose
- 1x SMK-20-G1/4-B-C-W3
- 1x SMK-20-M10x1-B-A-W3
- Sample bottles

Order Codes

SFSK-1

①

① Series and Type

NPT type	SFSK-1
BSP type	SFSK-2





Preventative maintenance and servicing is playing an increasingly relevant role today to guarantee the trouble-free operation of plant and machinery.

With hydraulic and lubricating oil systems, the main focus is on preventative monitoring of their condition and analysis of the fluids used. Apart from the purity of the oils, which can be determined using mobile or stationary STAUFF LasPac-II and LPM-II Laser Particle Counters, oil ageing is a second important criterion for the decisive and comprehensive determination of the condition of a system.

Lubricants and operating media age with progressive use. Old or used oils can sometimes no longer guarantee the necessary protection of system components from wear, a factor that can decisively impair the operation of sensitive components in particular. Quite often this means repairing or replacing the affected components, which usually results in expensive downtimes and unplanned oil changes.

The STAUFF OCS Oil Condition Sensor continuously monitors the condition of hydraulic and lubricating oils and displays this in real time on the OCD Oil Condition Display, optionally available as an accessory.

The OCD displays the values recorded by the OCS sensor on a multi-segment display, which enables the oil condition and temperature to be recorded at a glance without the need to connect to a PC.

The data can, of course, also be transmitted directly into the machine control or to a PC, if required. More important, a multi-coloured LED provides the ACTUAL condition in relation to the TARGET condition, which enables demand-led maintenance and oil change intervals to be planned.



Oil Condition Sensor - Type OCS-I-M-B08-M16

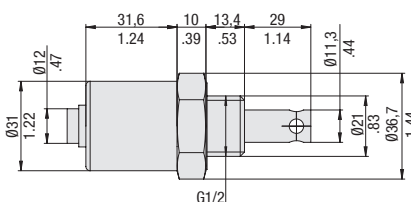

Product Description

The Oil Condition Sensor OCS is designed for continuous monitoring of hydraulic systems. Permanently installed in the system the OCS sensor monitors the condition of hydraulic fluids and lubricating oils in real time, whereby water ingress and oxidation can be detected in time. The OCS sensor is 60 times more sensitive than dielectric sensors on increasing contamination and protects the system from cost-intensive downtimes and reduces machine downtimes.

Technical Data

Materials

- Stainless Steel (corrosion-resistant Steel) AISI304, 1.4301

Dimensions

- 90 x 37 mm / 3.54 x 1.46 in

Weight

- 160 g / .35 lbs

Sealing Material

- FKM (Viton®)

Features

- Robust construction
- Usage under extreme conditions with temperatures from -20 °C to +120 °C / -4 °F to +248 °F
- Suitable for use at operating pressures up to 20 bar / 290 PSI

Max. Burst Pressure

- 20 bar / 290 PSI

Media Temperature

- 20 °C ... +120 °C / -4 °F ... +248 °F

Media Compatibility

- Mineral and Synthetic Oil
(Please contact STAUFF for other fluids)

Process Connection

- G1/2

Order Code

OCS-I-M-B08-M16



① Series

Oil Condition Sensor (only) **OCS-I-M-B08-M16**

Electrical Connection

- 6-pin connection plug

Power Supply

- 9 ... 30 V DC

Analog Output

- 4 ... 20 mA

Computer Interface

- RS485

Protection Rating

- IP67

USB Interface - Type Interface-OCS-I-USB

Product Description

The OCS sensor respectively the Display-OCS-I can be connected to a PC or laptop using the Interface-OCS-I-USB. It allows you to download the measured data and to carry out programming using the supplied software.

The Interface-OCS-I-USB was not designed for a permanent operating and should be used for programming the OCS sensor respectively download the measured data from the Display-OCS-I only.

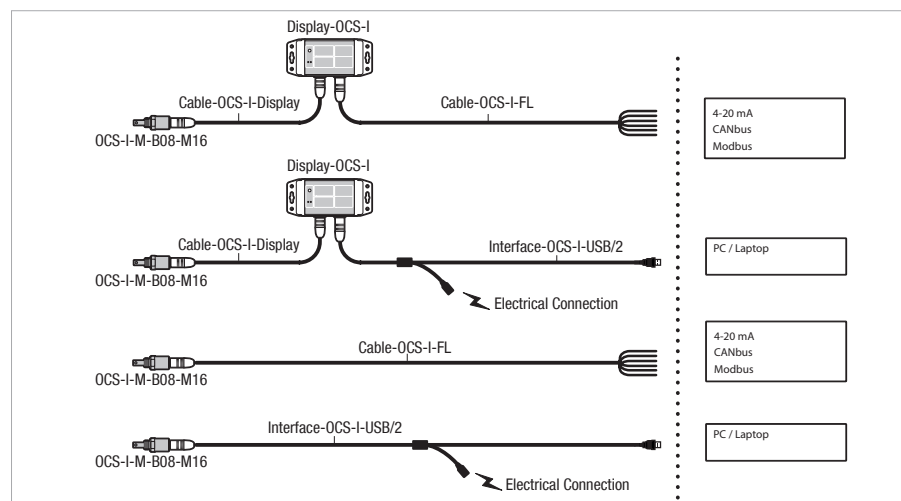

Order Code

Cable-OCS-I-Display



① Series

Connection Cable **Cable-OCS-I-Display**

Order Code

Interface-OCS-I-USB/2



① Series

Connection Cable **Interface-OCS-I-USB/2**

Order Code

Cable-OCS-I-FL



① Series

Connection Cable **Cable-OCS-I-FL**



Oil Condition Display ▪ Type Display-OCS-I

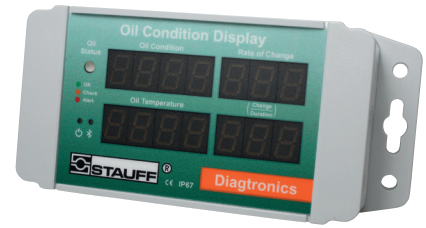
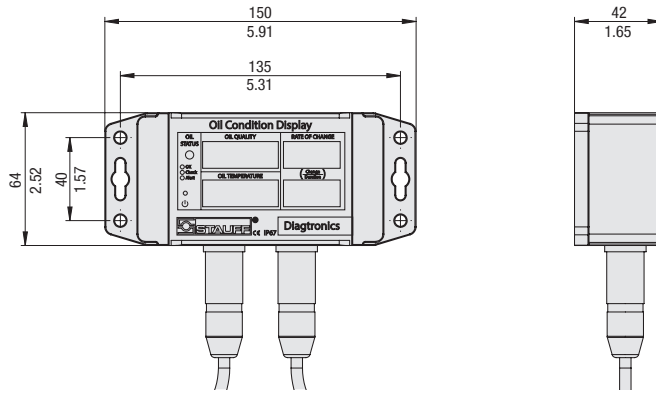

Order Code

Display-OCS-I



① Series

Oil Condition Display OCS **Display-OCS-I**

Product Description

The optional Oil Condition Display OCS unit shows the values measured by the sensor using a multi-segment LED indicator, which makes the oil condition apparent at a glance and without any connection to a PC.

The display unit also has integrated measurement value memory, from which the data can be subsequently transferred for assessment via USB.

Technical Data

Materials

- Polycarbonate

Dimensions

150 x 64 x 42 mm / 5.91 x 2.52 x 1.65 in

Weight

- 250 g / .35 lbs

Power Supply

- 9 ... 30 V DC

Analog Output

- 4 ... 20 mA

Computer Interface

- RS485, 9600 Baud (half duplex)

Mounting

- Mounting flange on back side
150 x 64 mm / 5.91 x 2.52 in

Protection Rating

- IP67

Display

- Multi-segment LED indicator
(20 segments: 13 green LED, 4 amber LED, 3 red LED, 1 red LED (Unit ON))

Order Code

Starterkit-OCS-I



① Series

Starterkit **Starterkit-OCS-I**

Includes

- 1x Oil Condition Sensor - Type OCS-I-M-B08-M16
- 1x Oil Condition Display - Type Display-OCS-I
- 1x Connection Cable - Type Cable-OCS-I-Display
- 1x Connection Cable - Type Interface-OCS-I-USB/2
- 1x Connection Cable - Type Cable-OCS-I-FL

Starterkit ▪ Type Starterkit-OCS-I

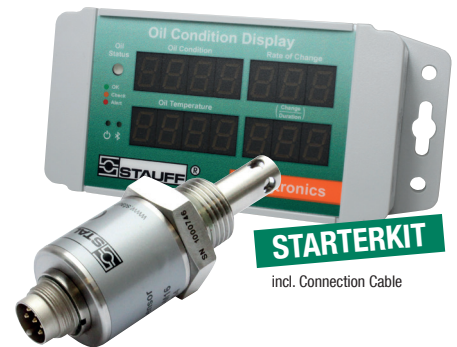

STARTERKIT

incl. Connection Cable



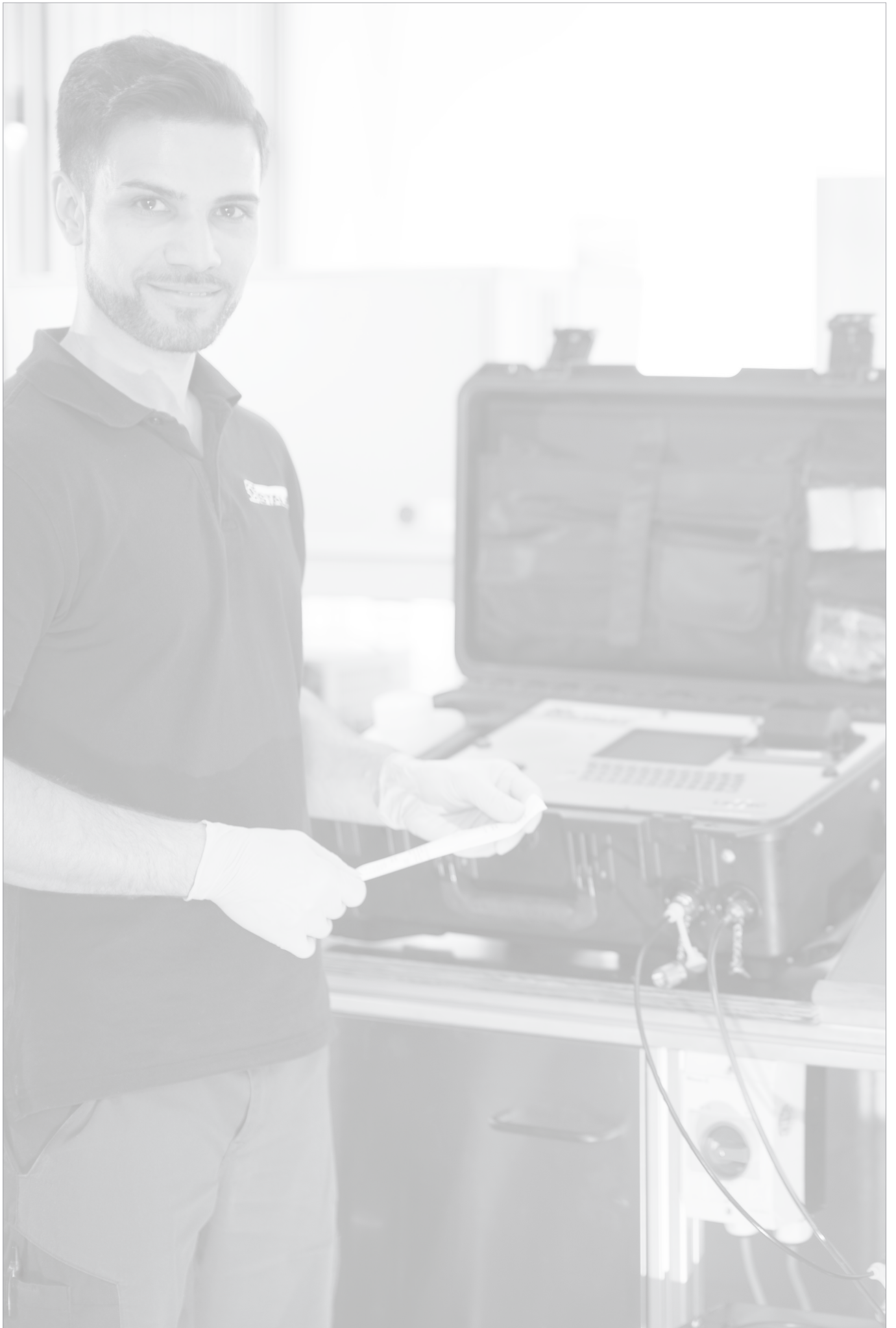

Product-Specific Abbreviations	80
Global Contact Directory	82 - 83



Product-Specific Abbreviations

Abbreviation	Product Category	Product Description	Page
Bottle-Sampler-LasPaC-II	Oil Analysis Equipment	Bottle Sampler Unit	66
Display-LPM-II-Remote	Oil Analysis Equipment	Particle Monitor	71
Interface-LPM-II-USB/ETH	Oil Analysis Equipment	Particle Monitor Interface	71
LasPaC-II-M	Oil Analysis Equipment	Laser Particle Counter (Mobile)	64
LasPaC-II-P	Oil Analysis Equipment	Laser Particle Counter (Portable)	62
LPM-II	Oil Analysis Equipment	Particle Monitor	70
LPM-II- ... -CX	Oil Analysis Equipment	Particle Monitor (ATEX)	73
LPM-II-DAV	Oil Analysis Equipment	Flow Control Valve	72
OCS	Oil Analysis Equipment	Oil Condition Sensor	76
PPC-04/06/08-plus	Hydraulic Testers	Complete Systems	46
PPC-04/12-P	Hydraulic Testers	Pressure Sensors	34
PPC-04/12-PT	Hydraulic Testers	Pressure / Temperature Sensors	38
PPC-04/12-SDS-CAB	Hydraulic Testers	Rotational Speed Sensor	42
PPC-04/12-SFM	Hydraulic Testers	Flow Turbine	40
PPC-04/12-T	Hydraulic Testers	Temperature Sensors	36
PPC-04-CAN-SET	Hydraulic Testers	Complete Systems	47
PPC-04-plus	Hydraulic Testers	Hydraulic Testers	28
PPC-04-plus-CAN	Hydraulic Testers	Hydraulic Testers	28
PPC-06/08-plus	Hydraulic Testers	Hydraulic Testers	29
PPC-CAN-FR	Hydraulic Testers	CAN Frequency Converter	45
PPC-CAN-P	Hydraulic Testers	Pressure Sensors	35
PPC-CAN-PT	Hydraulic Testers	Pressure / Temperature Sensors	39
PPC-CAN-SFM	Hydraulic Testers	Flow Turbine	41
PPC-CAN-T	Hydraulic Testers	Temperature Sensors	37
PPC-Pad	Hydraulic Testers	Hydraulic Testers	30
PPC-Pad-SET	Hydraulic Testers	Complete Systems	48
PT-RF	Hydraulic Testers	Pressure Transmitter	52
PT-RF-SET	Hydraulic Testers	Pressure Transmitter (Complete Systems)	54
Reader-PT-RF	Hydraulic Testers	Pressure Transmitter Reader	53
SDM	Hydraulic Testers	Flow Indicators	56
SDMKR	Hydraulic Testers	Flow Indicators	56
Sensorconverter-PPC	Hydraulic Testers	Current / Voltage / Frequency Converter	43
SFSK-1 /-2	Oil Analysis Equipment	Oil Sampling Kit	74
SMB-20 / SMB-15	Pressure Gauges	Analogue Pressure Test Kit	18
SMB-DIGI	Pressure Gauges	Digital Pressure Test Kit	21
SPG	Pressure Gauges	Analogue Pressure Gauge	16
SPG-DIGI	Pressure Gauges	Digital Pressure Gauge	20
SBAA /SDAA	Hydraulic Testers	Accumulator Adaptor for Pressure Transmitter	55



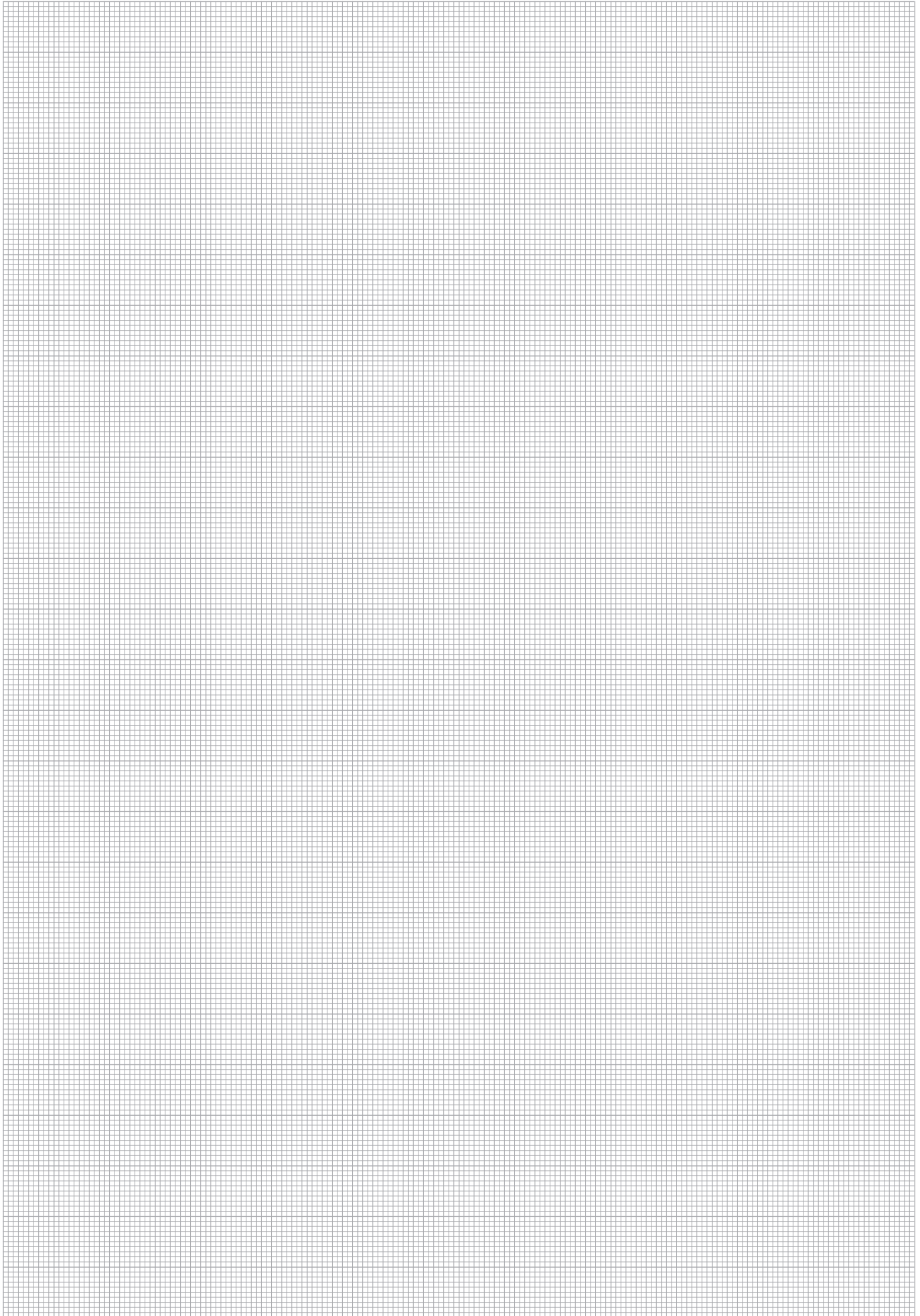

Global Contact Directory

STAUFF products and services are globally available through wholly-owned subsidiaries and a tight network of authorised distributors and representatives in all major industrial regions of the world.

Contact information on this page may be subject to changes and additions over time. Frequently updated and complete contact information can always be found at www.stauff.com.

Germany



Walter Stauffenberg GmbH & Co. KG

Im Ehrenfeld 4
58791 Werdohl
Tel.: +49 2392 91 60
Fax: +49 2392 91 61 60
E-Mail: sales@stauff.com
www.stauff.com



Neuenrade-Küntrop Logistics Centre
Wasserburgstraße 35
58809 Neuenrade



Plettenberg-Ohle Production Site
Lennestraße 2
58840 Plettenberg



Voswinkel GmbH

Neugrünenthal
58540 Meinerzhagen
Tel.: +49 2354 70 50
Fax: +49 2354 70 51 50
E-Mail: info@voswinkel.net
www.voswinkel.net

Europe

France

STAUFF S.A.S.
230, Avenue du Grain d'Or
Z.I. de Vineuil - Blois Sud
41354 Vineuil-cedex
Tel.: +33 2 54 50 55 50
Fax: +33 2 54 42 29 19
E-Mail: direction@stauffsa.com
www.stauff.fr

Ireland

STAUFF UK Ltd.
Block B, 9 Ferguson Drive
Knockmore Hill Industrial Estate
Lisburn, County Antrim, BT28 2EX
Tel.: +44 2892 60 69 00
Fax: +44 2892 60 26 88
E-Mail: sales@stauffireland.com
www.stauff.co.uk

Italy

STAUFF Italia s.r.l
Via Borima 21 (Frazione Borima)
23867 Suello (LC)
Tel.: +39 031 65 84 94
Fax: +39 031 65 50 05
E-Mail: sales@stauff.it
www.stauff.it

Poland

STAUFF Polska Sp. z o.o.
Miszewko 43 A
80-297 Banino
Tel.: +48 58 660 11 60
Fax: +48 58 629 79 52
E-Mail: sales@stauff.pl
www.stauff.pl

Russian Federation

STAUFF LLC
Building 1
19, Leninskaya Sloboda
Moscow, 115280
Tel.: +7 495 276 16 50
Fax: +7 495 276 16 51
E-Mail: sales@stauff.ru
www.stauff.ru

United Kingdom

STAUFF UK Ltd.
500, Carlisle Street East
Off Downgate Drive
Sheffield, S4 8BS
Tel.: +44 114 251 85 18
Fax: +44 114 251 85 19
E-Mail: sales@stauff.co.uk
www.stauff.co.uk

STAUFF UK Ltd.
Badentoy Avenue
Badentoy Industrial Estate
Portlethen, Aberdeen, AB12 4YB
Tel.: +44 1224 78 61 66
Fax: +44 1224 78 61 77
E-Mail: sales@stauffscotland.co.uk
www.stauff.co.uk

STAUFF UK Ltd.
Unit 9, Southampton Trade Park
Third Avenue, Millbrook
Southampton, SO15 0AD
Tel.: +44 2380 69 87 00
Fax: +44 2380 69 87 01
E-Mail: sales@stauffsouthampton.co.uk
www.stauff.co.uk

Further branch offices in
Engels, Volzhskiy, Magnitogorsk,
Nizhny Novgorod and St. Petersburg.

North America

Canada

STAUFF Canada Ltd.
866 Milner Avenue
Scarborough
Ontario M1B 5N7
Tel.: +1 416 282 46 08
Fax: +1 416 282 30 39
E-Mail: sales@stauffcanada.com
www.stauffcanada.com

United States

STAUFF Corporation
7 Wm. Demarest Place
Waldwick, 07463-1542
New Jersey
Tel.: +1 201 444 78 00
Fax: +1 201 444 78 52
E-Mail: sales@stauffusa.com
www.stauffusa.com

Further branch office in
Canton, Michigan.

South America

Brazil

STAUFF Brasil Ltda.
Avenida Gupê 10767
Galpão 2 - Bloco A
Barueri, São Paulo, CEP 06422-120
Tel.: +55 11 47 72 72 00
Fax: +55 11 47 72 72 10
E-Mail: stauff@stauffbrasil.com
www.stauffbrasil.com



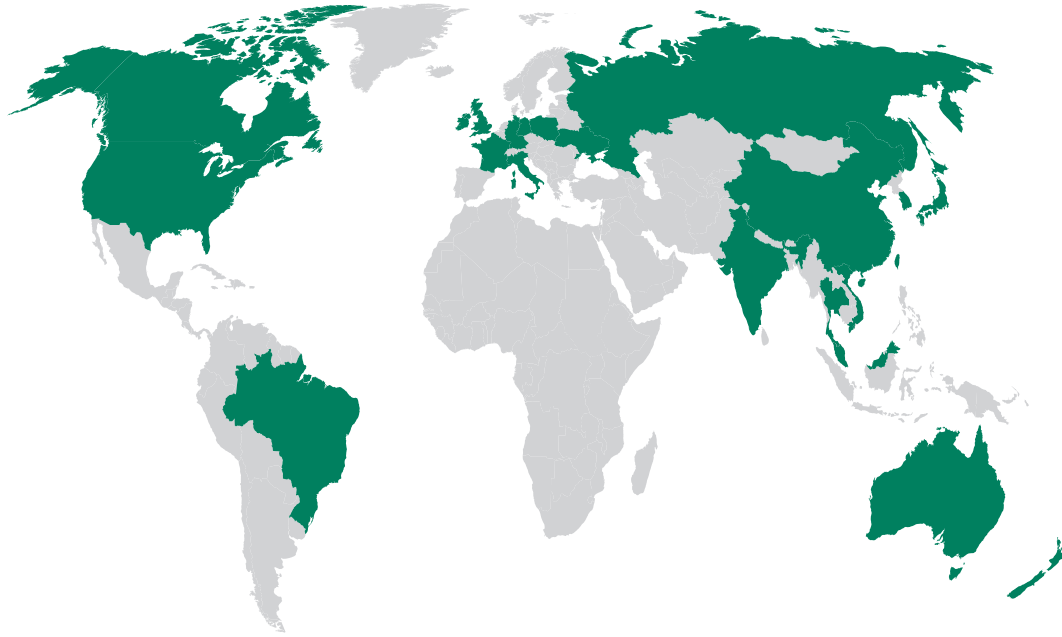

Asia

China

STAUFF CHINA

Building 1, No. 128, Die Qiao Road
Jushuo Industrial Zone, Kang Qiao
Shanghai, 201319
Tel.: +86 21 68 18 70 00
Fax: +86 21 68 18 71 36
E-Mail: info@stauff.com.cn
www.stauff.com.cn

Further branch offices in Beijing,
Changsha, Chengdu, Changchun,
Chongqing, Jinan, Harbin, Guangzhou,
Shenyang, Wuhan, Xian and Xuzhou.

India

STAUFF India Pvt. Ltd.

Gat no. 26/1 & 27, Sanghar Warehousing
Pune - Nagar Road
Lonikand - 412216
Tel.: +91 20 6731 4900
Fax: +91 20 6731 4905
E-Mail: sales@stauffindia.com
www.stauffindia.com

Korea

STAUFF Korea Ltd.

105, Hwajeonsandan 5-ro
Gangseo-gu
Busan, 46739
Tel.: +82 51 266 6666
Fax: +82 51 266 8866
E-Mail: info@stauff.co.kr
www.stauff.co.kr

Malaysia

STAUFF South East Asia Sdn Bhd

No. 8, Jalan SS13/6A
Subang Jaya Industrial Estate
47500 Subang Jaya
Tel.: +60 3 5637 78 88
Fax: +60 3 5636 78 90
E-Mail: sales@stauff.com.my
www.stauff.com.my

Thailand

STAUFF (Thailand) Co., Ltd.

10 Soi On-Nut 74/4
Pravet District
Bangkok 10250
Tel.: +66 2 721 73 23 / 24
Fax: +66 2 721 73 35
E-Mail: sales@stauff.co.th
www.stauff.co.th

Vietnam

STAUFF Vietnam Ltd.

2nd Floor, CT-IN Building
#435 Hoang Van Thu Street
Tan Binh District, Ho Chi Minh City
Tel.: +84 8 3948 10 41 / 42
Fax: +84 8 3948 10 44
E-Mail: sales@stauff.com.vn
www.stauff.com.vn

Oceania

Australia

STAUFF Corporation Pty Ltd

24-26 Doyle Avenue
Unanderra NSW 2526
Tel.: +61 2 4271 9000
Fax: +61 2 4271 8432
E-Mail: sales@stauff.com.au
www.stauff.com.au

Further branch offices in
Adelaide, Brisbane, Melbourne
and Sydney.

New Zealand

STAUFF Corporation (NZ) Ltd.

Unit D, 103 Harris Road
East Tamaki, Auckland 2013
Tel.: +64 9 271 48 12
Fax: +64 9 271 48 32
E-Mail: sales@stauff.co.nz
www.stauff.co.nz



Introduction

Pressure Gauges

Hydraulic Testers

Oil Analysis Equipment

Appendix



Catalogue 8 STAUFF Diagtronics

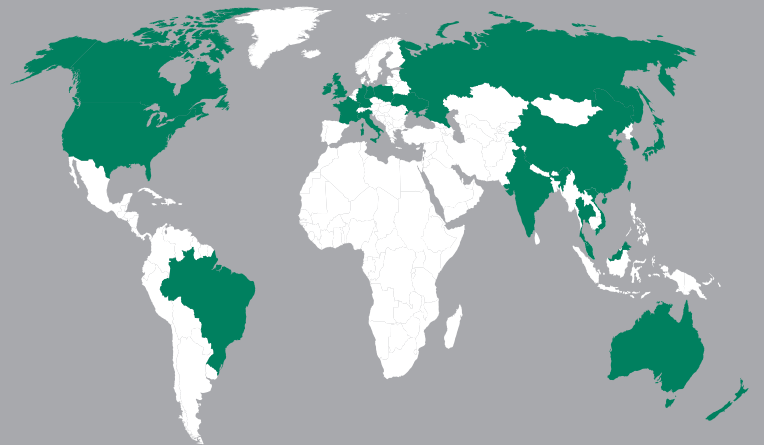

Germany

Walter Stauffenberg GmbH & Co. KG
Im Ehrenfeld 4
58791 Werdohl
Tel.: +49 2392 91 60
Fax: +49 2392 91 61 60
E-Mail: sales@stauff.com

STAUFF products and services are globally available through wholly-owned subsidiaries and a tight network of authorised distributors and representatives in all major industrial regions of the world.

You can find detailed contact information on the last two pages of this product catalogue or at

www.stauff.com